



OWNER'S MANUAL

LABELING PRINTING SCALES



W-LABEL Series

BEFORE OPERATING THIS SCALE, PLEASE READ THIS MANUAL THOROUGHLY

INDEX

1. - INTRODUCTION.....	5
2.- TECHNICAL SPECIFICATIONS DESCRIPTION.....	6
3. - LABEL WEIGHING SCALE PARTS & THERMAL PAPER ROLL.....	7
4. - USAGE RECOMENDATIONS.....	10
4.1.-INFORMATION OF PRODUCT TYPES.....	10
5. - DISPLAYS DESCRIPTION.....	11
6. - TOUCHPAD DESCRIPTION.....	12
7. - ENTERING THE SETUP MENU.....	16
8. - SETTING OPERATING MODES SELECTING OR TICKETS.....	16
8.2. - SCALE CONFIGURATION IN PRE-PACK (LABEL) MODE OR POINT OF SALE (TICKET)....	17
9.- MISCELLANEOUS PRODUCT CONFIGURATION.....	18
10.- FIXED PRICE SETTING.....	20
11.- KEYBOARD MODE SETTINGS.....	21
12.-PRODUCTS CONFIGURATION.....	22
12.1.- CREATING A PRODUCT.....	23
12.2.- EDIT A PRODUCT.....	25
12.3.- DELETE A PRODUCT.....	27
13-RED SETTINGS.....	28
13.1.1- WIFI INFO.....	29
13.1.2. ETHERNET INFO.....	30
13.1.3- NETWORK INFO ADHOC <HOT SPOT>.....	31
13.2.- TYPE OF CONNECTION CONFIGURATION.....	33
13.2.1.- WIFI CONNECTION CONFIGURATION.....	34
13.2.2.- ETHERNET CONFIGURATION.....	36
13.2.3.- ADHOC <HOT SPOT> CONECTION CONFIGURATION.....	39
14.-PRINTER CONFIGURATIONS.....	41

14.2.- PRINTER CONTRAST SETTINGS.....	42
15-DATE AND TIME SETTINGS.....	43
15.1.-SEE DATE AND TIME.....	43
15.2.- SET DATE.....	44
15.3.- SET TIME.....	44
15.4.-DATE FORMAT SETTINGS.....	45
16.-MEMORY SETTINGS.....	47
16.1.- DELETE SALES.....	47
16.2.- DELETE PRODUCTS.....	48
16.3.- DELETE ALL.....	48
17.-LANGUAGE SETTINGS.....	50
18.-SCALE INFORMATION.....	51
19.- SCALE'S OPERATION.....	52
19.1.- ADJUST TO ZERO.....	52
19.2- TARE FUNCTION.....	52
19.3.- AGENT SELECTION.....	53
19.4.- FIXED PRICE SELECTION.....	53
19.5.- PAPER FEED.....	54
20.- PLU SELECTION.....	54
21.- NON-PLU SALE.....	55
22.- NON-PLU NON WEIGHTABLE SALE.....	55
23.- PRODUCT SALE.....	56
23.1.- PRE – PACKING MODE- WEIGHABLE PRODUCTS SALE.....	56
23.2.- PRE-PACKING MODE – NON-WEIGHABLE PRODUCTS SALE.....	57
23.3.- PRE-PACKING MODE – SELL OF SEVERAL WEIGHABLE PRODUCTS.....	58
23.4.- PRE-PACKING MODE- SALE OF NON-WEIGHABLE NON-PLU PRODUCTS.....	59
23.5.- POINT OF SALE MODE – WEIGHABLE AND NON-WEIGHABLE PRODUCTS SALE.....	59

24.- APPLY DISCOUNTS.....	61
25.- RETURNS.....	62
25.1 IMMEDIATE RETURN.....	62
25.2 LATER RETURN.....	63
26.- CHANGE OPERATION (TICKET).....	64
27.- SCALE LINK MOBILE APP.....	65
27.1.- SET CONNECTION WITH SCALE.....	67
27.2.- PRODUCT SECTION.....	70
27.3.- AGENT SECTION.....	71
27.4.- OFFER SECTION.....	72
27.5.- ADDITIONAL INFORMATION SECTION.....	73
27.6.- REPORT SECTION.....	74
27.7.- SETTINGS SECTION.....	75

1. - INTRODUCTION.

The newest labeling scale W-LABEL offers a weighing method and a very easy way to sell products precisely. Users will be able to monitor their sales behavior, returns and effectiveness of your workers. It also has a remote administration system and the capacity to connect to several scales at the same time.

Characteristics:

- Stainless Steel cabinet and plate.
- Carbon steel base.
- Thermal printer.
- Keyboard.
- Bubble Level and adjustable feet.
- Permanent backlight on both displays.
- Display for weight, unit price and total price.
- Operator display.
- Modes of Pre-packing and Point of Sale.
- Prices per lb. or piece.
- Advertising messages.
- Ability to manage up to 20 vendors.
- Ethernet and WIFI connection (optional).
- Scale Link PC management software.
- Applications for Scale Link mobile devices.
- Downloadable from AppStore or Play Store.
- Capacity to store up to 500 PLUs
- 35 PLU Shortcuts.

2.- TECHNICAL SPECIFICATIONS DESCRIPTION.

A table showing the characteristics of the WLABEL Scale in the capacities of 40 lb.



Model	W-LABEL40L	
Capacity.	40 lb.	
Minimum Division.	0.010 lb.	
Programmable memories.	500 PLUs	
Interface.	Keyboard	
Power cord	Included	
Power	110/220 VCA 60/50Hz	
Max Tare	9,99 lb.	
Plate's Dimensions	38cm (L) x 30cm (w)	
Max Unit Price	\$ 999,99	
Max Total Price	\$ 9999,99	
Temperature of operation	14°F to 104 °F (-10°C to 40°C)	
Storage Temperature	-4°F to 122 °F (-20°C to 50°C)	
Net Weight	27.833 lb.	27.833 lb.
Weight with packaging	37.478 lb.	37.478 lb.

3. - LABEL WEIGHING SCALE PARTS & THERMAL PAPER ROLL.

Within the scale's package W-Label you will find the following:

- 1 Scale W-LABEL.
- 1 Power Cable.
- 1 Thermic paper roll.
- 1 roll with 750 thermic labels.
- 1 Turret Display.
- 1 WIFI antenna (optional).
- 1 Allen Wrench 3/16".
- 1 Allen Wrench 1/8".
- 2 screws 10-24 socket head.
- 3 screws ¼" socket head.
- 1 turret's cover base.
- 1 unpacking guide.
- 1 Turret's Installation Guide.
- 1 Quick Usage Guide

Scale's Parts:

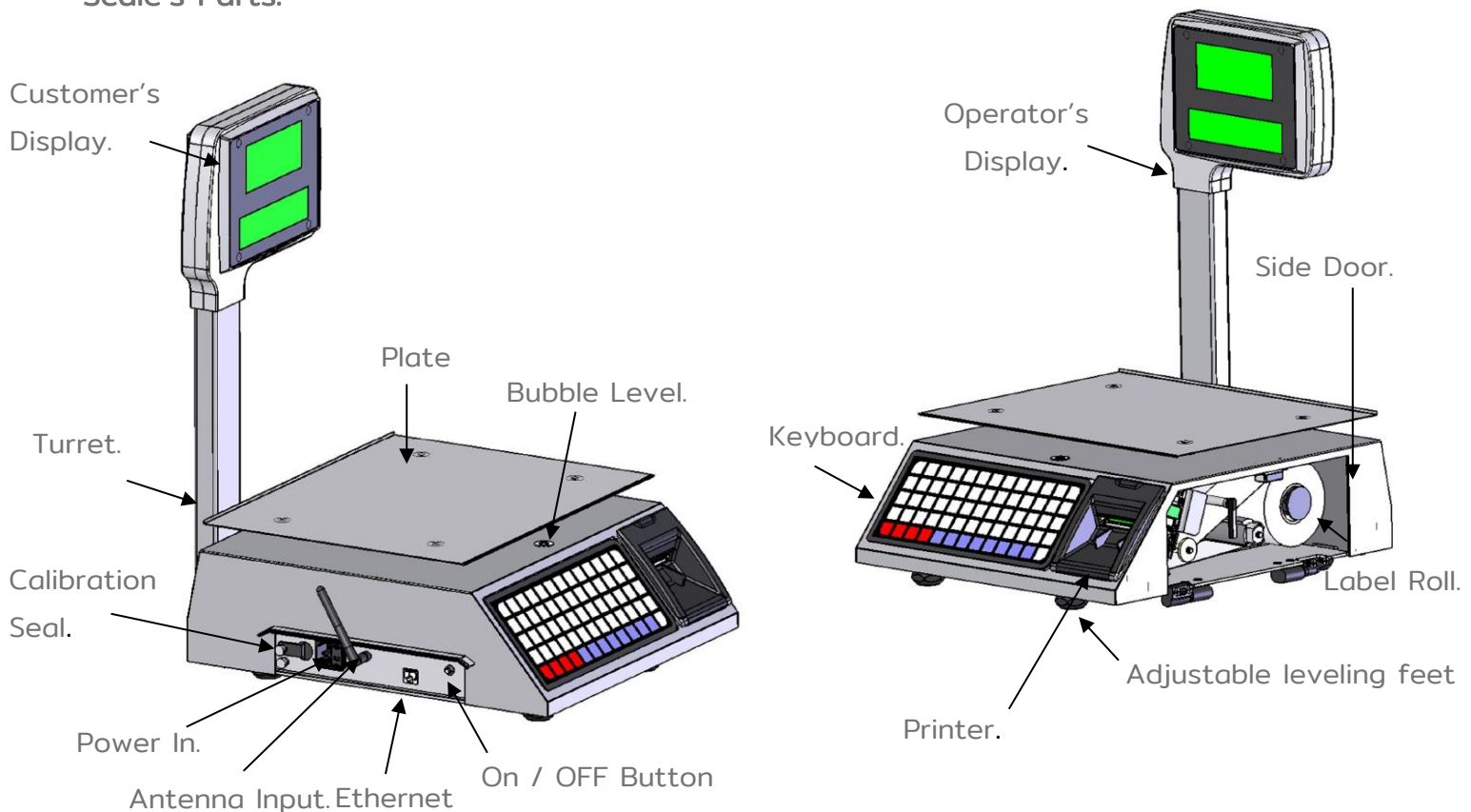

3.1. - LABELING PRE-PACKING MODE

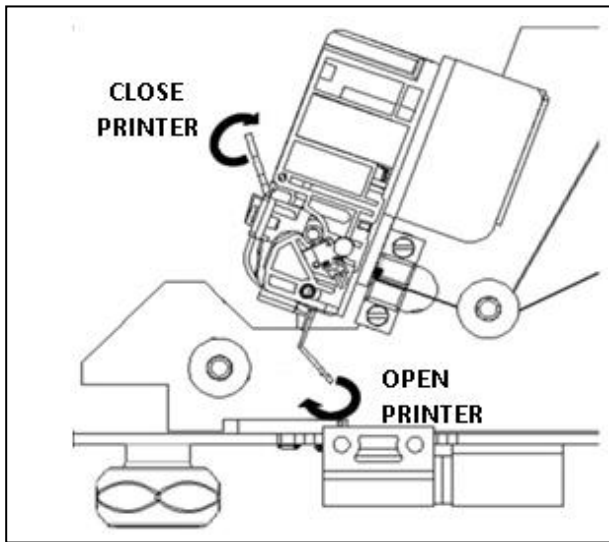

* Printer Opening:

Pull the release lever on the right side of the scale toward the front of the scale as shown in the image on the left.

* Closing the Printer:

Once the roll of labels or tickets has been installed, lift the lock lever on the front of the scale.

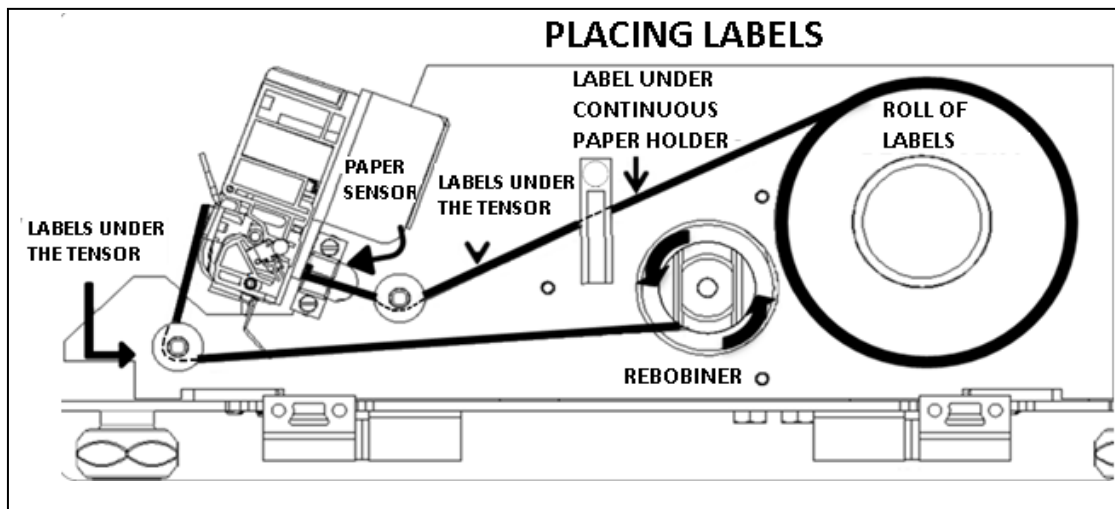

1. - Open the printer.
2. - Place the roll of labels in the roll holder.
3. - Unroll 30cm and remove 6 labels from the roll manually, make sure it passes under the tensioners and through the paper sensor.
4. Wrap the remaining residue of the roll counterclockwise.
5. - Close the printer.

3.2. - TICKET PLACEMENT MODE OF SALE.

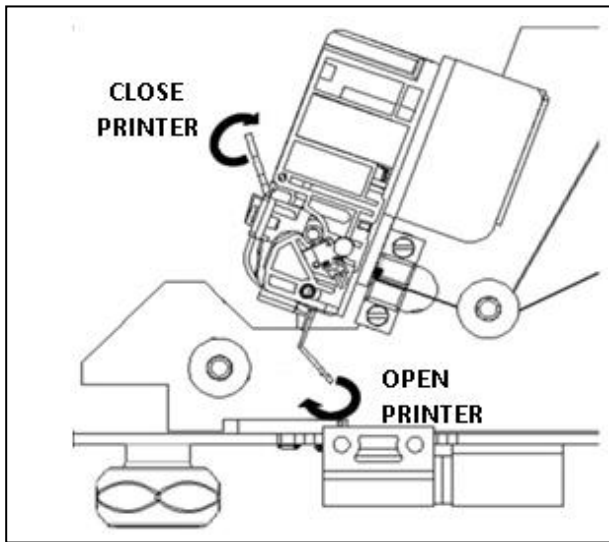

* Printer Opening:

Pull the release lever on the right side of the scale toward the front of the scale as shown in the image on the left.

* Closing the Printer:

Once the roll of labels or tickets has been installed, lift the lock lever on the front of the scale

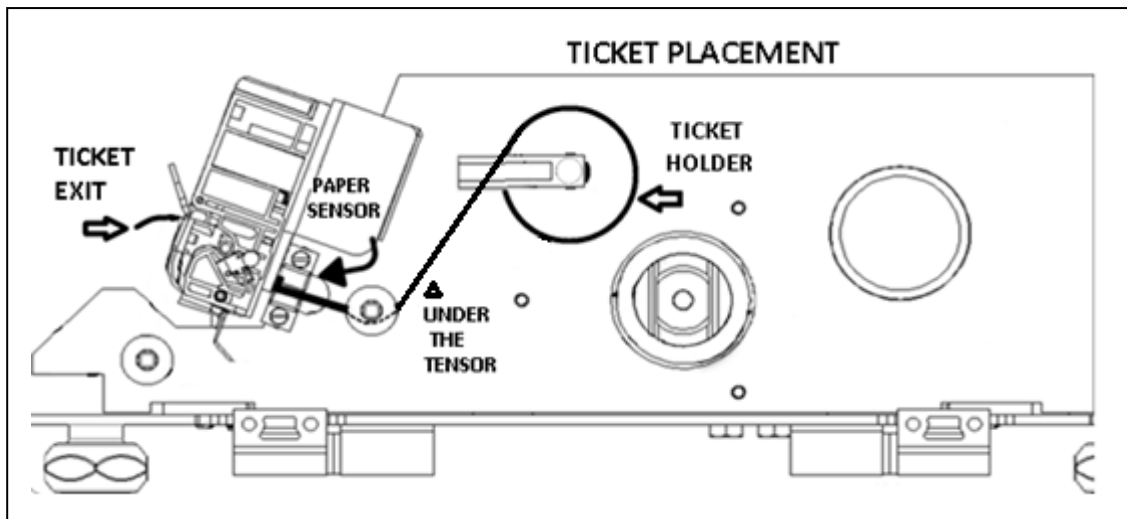

1. - Open the printer.
2. - Place the ticket roll in the secondary roll holder.
3. - Unroll 20cm of paper make sure it passes under the tensioner and through the paper sensor.
4. - Allow 5cm of thermal paper to print out of the printer.
5. - Close the printer.

4. - USAGE RECOMENDATIONS.

- Avoid installing the scale in unstable places.
- Place the scale only on rigid, flat and level surfaces.
- Avoid energizing the scale in unregulated outlets.
- Avoid placing fans or heaters directed at the scale.
- Avoid operating the scale with sharp objects such as knives, razors, pencils, pens, etc.
- Use a slightly damp cloth to clean the scale.
- Do not strike the scale plate with the object to be weighed, this may damage the load sensor.
- Avoid opening the scale yourself as this will invalidate the warranty.

4.1.-INFORMATION OF PRODUCT TYPES.

Product Types.

The W-LABEL scale can handle four types of products: weighable, non-weighable and miscellaneous products, various non-heavy products.

Weighable Products.

These are products whose unit price is based on 1 lb. of their weight and have been programmed previously on the scale.

Non-Weighable Products.

These are products whose unit price is in function of 1 piece and have been programmed previously in the scale.

Other Products.

They are products whose unit price is in function of 1 lb. of their weight and they have not been programmed previously in the scale.

Non-Weighable Other Products.

They are products whose unit price is in function of 1 piece and have not been programmed previously in the scale.

5. - DISPLAYS DESCRIPTION.

The W-LABEL scale consists of the operator display and the customer display both show the same information to both operator and customer.

5.1. - OPERATOR AND CUSTOMER'S DISPLAY.

These displays are the main interface between the operator, customer and the scale as it is here that shows the information regarding the current operation, in addition to displaying advertising messages.

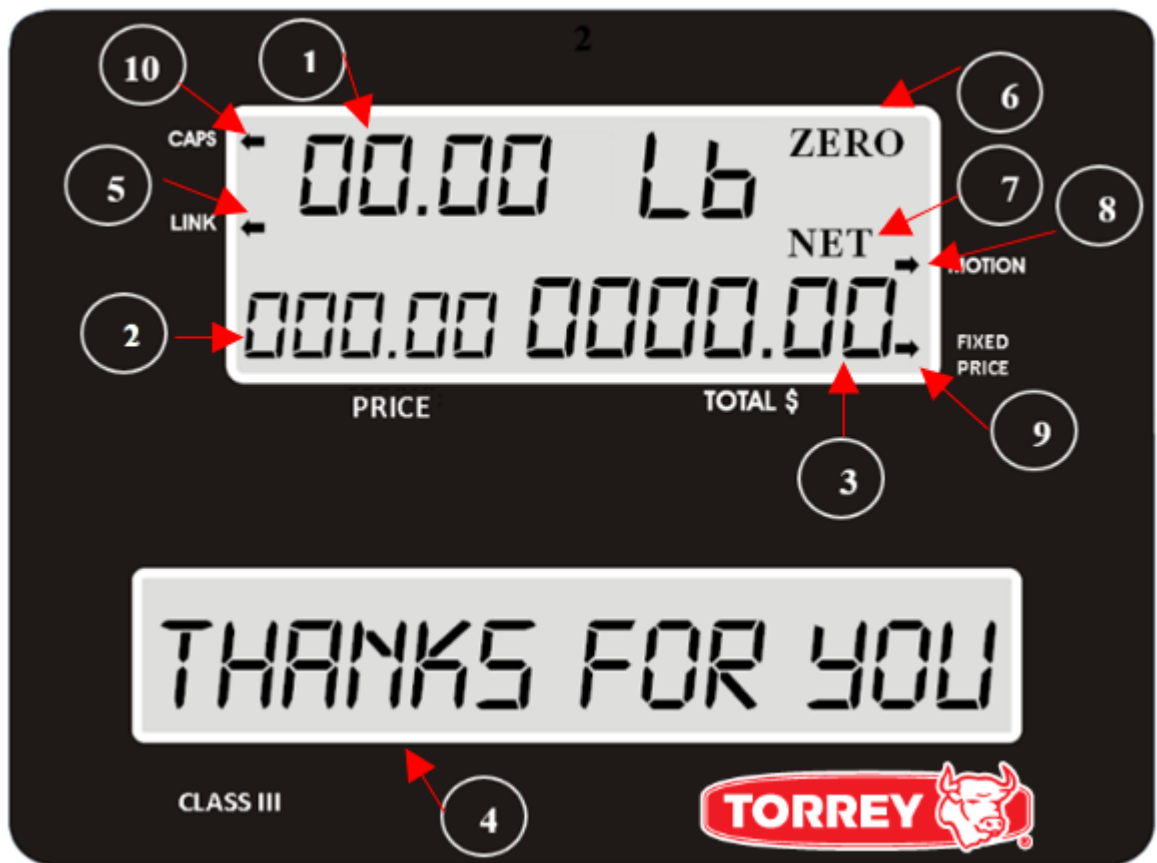

1. - Display of weight / quantity. Shows the quantity of product being sold.
2. - Display unit price. Shows the unit price of the selected product.
3. - Display of total price. Shows the total price of the sale.







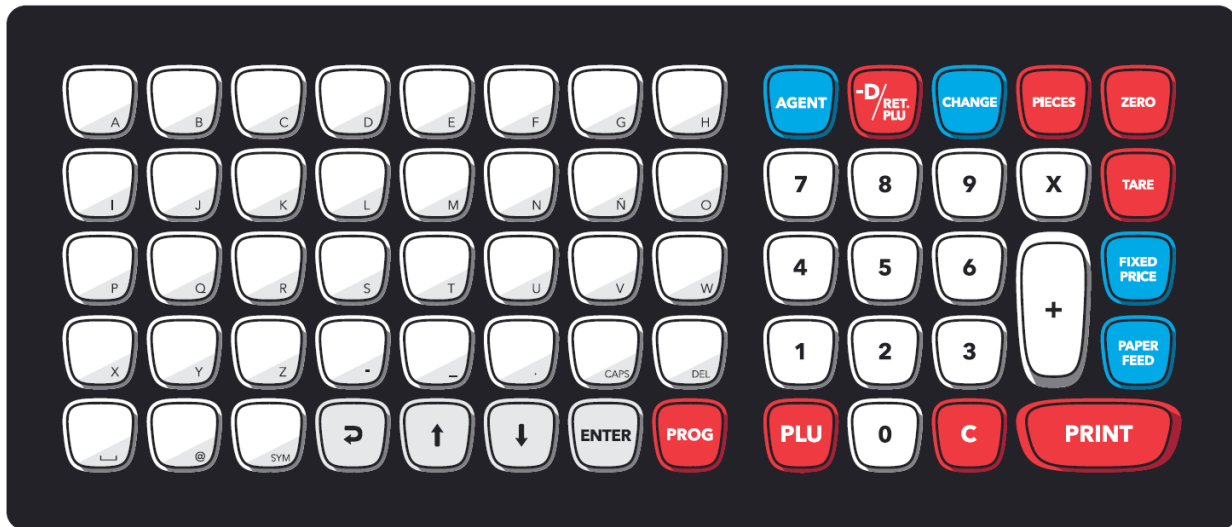

- 4.-Message display and PLU name. Displays the name of the selected product as well as the programmed messages.
5. - Connection indicator active LINK. Indicates whether the scale is connected to a device.
- 6.-ZERO icon. places the reference to zero.
7. - NET icon. Indicates that the TARE function is activated.
8. - MOTION Indicator. Indicates that there is movement that can alter the reading of the weight to be measured.
9. - Fixed Price Indicator. It is activated when the price per kilo of product does not change.
10. - Indicator CAPS. Indicates that the writing is in capital letters.



6. - TOUCHPAD DESCRIPTION.





This section shows the scale keys as well as the special functions.







Alphanumeric keyboard:

	<p>Opens the list of sellers registered and allows to select some to register their transactions.</p>
	<p>Allows the output of a label or a small stretch of thermal paper (ticket).</p>
	<p>Activates the Change operation, for more information, see Section 24. - Change Operation, page. 50.</p>
	<p>Activates the Fixed Price function (only in Pre-packing mode) for more Information see section 23.-Sale of Products Page 46.</p>
	<p>Enter the configuration menu with the user code. (Default 123456)</p>
	<p>It takes the numeric value entered as a PLU number, searches it in the Database and, if found, displays it on the display. In case of no the beacon will only emit a beep and will not show anything.</p>
	<p>Deletes the entered numeric value.</p>
	<p>Print on a label or ticket the weight and price of the products.</p>

	<p>It activates the sale of several non-weighable products or sale by pieces for more information see section 23 - Sale by Pieces. Pág.46.</p>
	<p>Allows you to take a new reference to zero weight.</p>

	<p>Activates TARE Function. (For further information go to section 20.2 – TAR Function Pag. 37).</p>
	<p>Returns the view to the previous navigation level, it is disabled when the minimum navigation level (main display) is reached.</p>
	<p>Navigation within menu options (previous).</p>
	<p>Navigation within the options of a menu (next).</p>
	<p>Change to lowercase letters or vice versa.</p>

	Delete previous character.
	Space bar.
	Displays special symbols that are not on the keyboard.
	GO / ENTER

The alphabetic keyboard when in **PRODUCT ENTRY** mode (enabled) is used to enter the name of the product while a sale is being made.

The alphabetic keyboard when in **DIRECT ACCESS** mode (enabled) is used to enter the PLUs stored in the internal memory.

Go to section **11 Keyboard Mode Settings Pag. 18.**

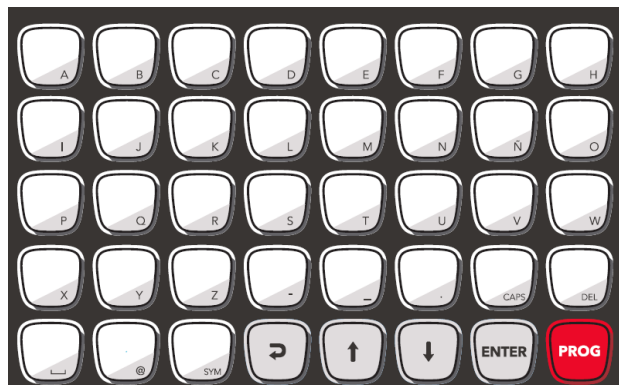

7. - ENTERING THE SETUP MENU.

This operation will be performed each time the user needs to modify any parameters previously set.



1.-Press the PROG button the word PASS will immediately appear in the advertising display: At this point, press the 123456 sequence and then press ENTER to enter the configuration



menu.

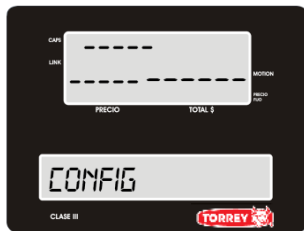

2.-Once inside the CONFIG menu, press ENTER to enter the different options of this menu.



The different options in the CONFIGURATION menu are:

1 GENERAL, 2 PRODUCTS, 3 NETWORK, 4 PRINTER, 5 DATE AND TIME, 6 MEMORY, 7 LANGUAGE, 8 INFORMATION.

Access each of these submenus with the STEERING KEYS and ENTER



Note: in step 1, you automatically jump to the first option in the configuration menu (1GENERAL) press the RETURN key once to enter the CONFIG root menu or 2 times

to exit.



8. - SETTING OPERATING MODES SELECTING OR TICKETS.

The labeling scale WLABEL has two modes of product sales: Pre-packaging mode and Point of Sale mode.

8.1.- WHAT ARE THE PRE-PACKING MODE (LABEL) OR POINT OF SALE (TICKET) MODE?.

The pre-packing mode is useful when it is desired to pre-pack containers or trays with a certain amount of a given product.

The point of sale mode will help you to issue descriptive tickets with the information of the products sold as well as give the exact change.

To enter the POS or pre-pack modes, you must configure the scale and install the roll of thermal labels (750) or the roll of thermal paper according to the instructions in the sections:

3.1.- Labeling Pre-packing Mode.

3.2.- Ticket Placement Mode of Sale.

8.2 Configuration of the Scale in Pre-Pause (Label) or Point of Sale (Ticket).

8.2. - SCALE CONFIGURATION IN PRE-PACK (LABEL) MODE OR POINT OF SALE (TICKET).

This section shows the steps to configure the WLABEL scale to print labels or tickets.

1.- Enter the **GENERAL** 1 submenu following the steps described in **section 7** entered the setup menu page. 14.

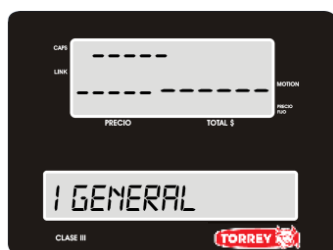

2. - Enter the 1GENERAL submenu by pressing ENTER



3.-Enter the OPERATION MODE submenu by pressing ENTER



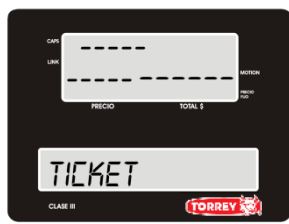

4.-Choose between the two options, TAG for PRE-PACKING mode or TIKET for POINT OF SALE mode.



Choose with the DIRECTION ARROWS
Then press ENTER.

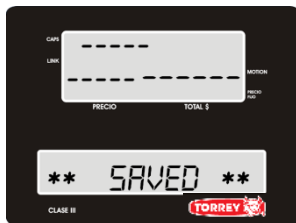

5.-When you save the changes, return to the OPERATION MODE menu, to exit and return to the normal functions of the scale only press the RETURN key 3



Ticket and label print.

9.- MISCELLANEOUS PRODUCT CONFIGURATION.

The various products are those of which a sale is made without having to be programmed in the scale previously, by enabling the function of VARIOUS PRODUCTS is allowing to enter products from the keyboard that normally are not entered in the memory of the scale.

At the time of printing the sale of a product weighable the predefined description will be that of "Item Ib.". For non-passable products, it will be "Item Pza".

1.- Enter the GENERAL 1 submenu following the steps described in section 7 entered the setup menu

p. 14

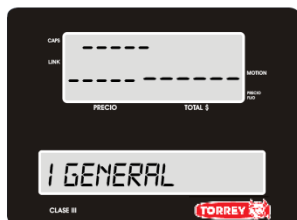

2.- Enter the submenu by pressing ENTER



3.-With the direction arrows choose the option.



MISCELLANEOUS PRODUCTS and press ENTER



4.- with the direction arrows select the option you find more convenient.



Press ENTER this will change your changes.

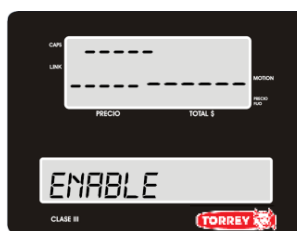

5.- Once changes are saved go back to sub-menu Miscellaneous Products, so you can go back to the main Screen or just press Return 3 times



10.- FIXED PRICE SETTING.

The fixed price setting prevents a product price (PLU) from being modified by the seller during the sales process.

When the price lock is enabled the scale will ask for the administrator password (123456 by default) to accept the new price (this price will not be stored in the scale memory).

When the price lock is disabled the scale will allow to change the price without requesting the password.

1.- Enter the GENERAL 1 submenu following the steps described in section 7 entered the setup menu p.14

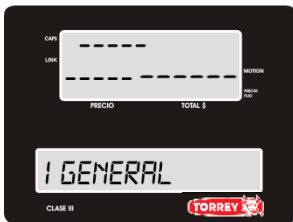

2.- Enter the 1GENERAL submenu by pressing ENTER



3.- Use the ARROW keys to select the option



FIXED PRICE and press ENTER.

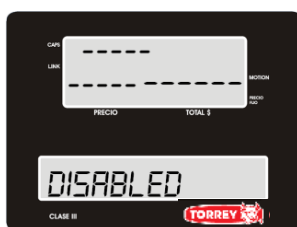
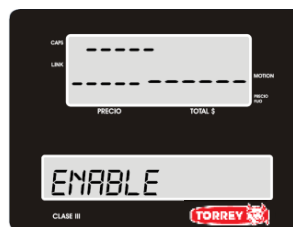

4.- With the ADDRESS arrows

Select the option that suits you best and



Press ENTER to save the changes.

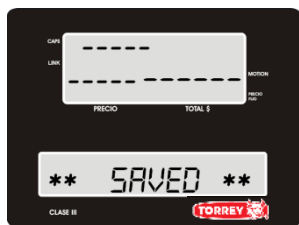

5.- Saving the changes returns you to the PRICE LOCK submenu, to exit and return to the normal functions of the scale just press the BACK key 3 times.



11.- KEYBOARD MODE SETTINGS.

The keyboard has two setup options, DIRECT ACCESS mode and PRODUCT INPUT mode.

In the DIRECT ACCESS mode, it will not be possible to enter new products during the sales operation.

In PRODUCT ENTRY mode it is possible to enter a new product during the sales operation, but they can't be stored in the product memory.

1.- Enter the GENERAL 1 submenu following the steps described in section 7 entered the setup menu **p.14**

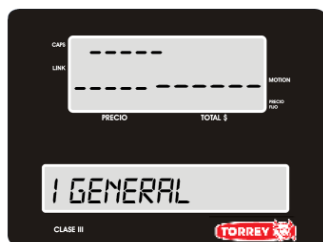

2.- Enter the 1GENERAL submenu by pressing ENTER



3.- Use the ARROW keys to select the option.



KEYBOARD MODE and press ENTER where you will enter the DIRECT ACCESS, PRODUCT ENTRY.



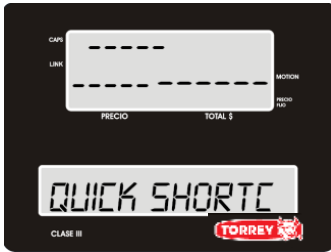

4.- Use the ADDRESS arrows to select the option that suits you best.

Press ENTER this will save the changes you've made.

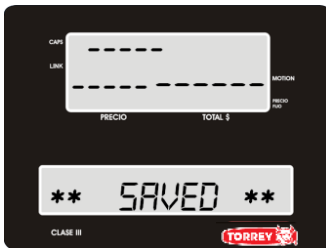

5.- Saving the changes returns you to the FIXED PRICE submenu, to exit and return to the normal functions of the scale just press the BACK key 3 times.



12.-PRODUCTS CONFIGURATION.

In the "2 PRODUCTS" submenu you can create new products, edit the existing products or delete any of them.

1.- Enter the 2 PRODUCTS submenus following the steps described in section 7 entered the configuration menu **p.14**



2.- Using the arrow key select the option



2 PRODUCTS and press ENTER



within this sub-menu you can find the following:

CREATE PRODUCT, EDIT PRODUCT and DELETE PRODUCT.



Choose any of these options with the arrow keys and Press ENTER to select it.



12.1.- CREATING A PRODUCT.



1.- To create a new product enter the CREATE PRODUCT option by following the steps in section 12 product configuration p.19 and then the sequence of this section.



You will use arrow keys and the ENTER button

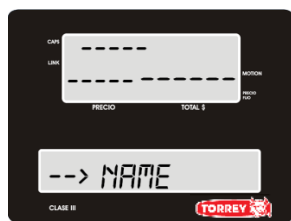

2.- Press ENTER



2.1.- Type the name of the new product and then

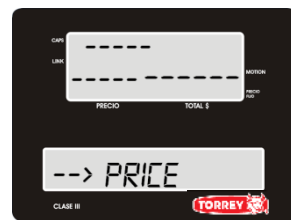

3.- Press Enter

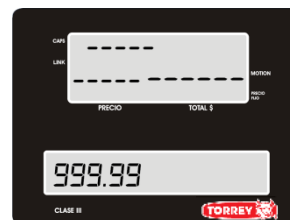

3.1- Type the Price less than 999.99 and press ENTER.

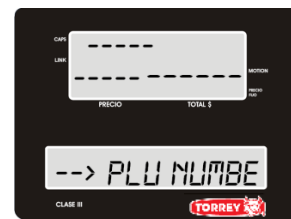

4.- Press Enter



4.1- By default the software adds a consecutive PLU number but it can be changed by the user, once you've finished press ENTER



5.- Press ENTER

Choose with the arrows pad the type of product and then press ENTER



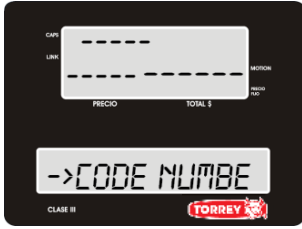

6.-Press:
ENTER.

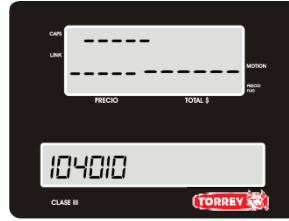

6.1- The scale by default assigns a new code for the product, but this can be changed by the user once he presses

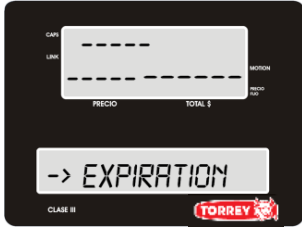

7.- Press Key
ENTER.
Expiration shall be expressed in days

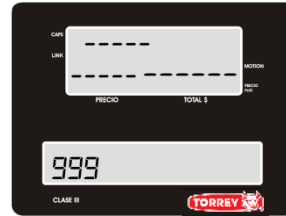

7.1- Enter the number of days.
(from 1 to 999)
The product will be fit for consumption

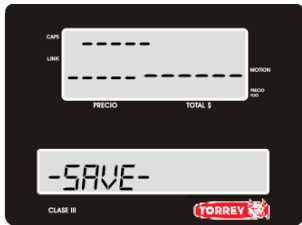

8.- Press key:
ENTER.

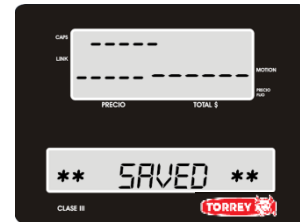

8.1- Wait a few seconds while the scale saves changes, and once it's

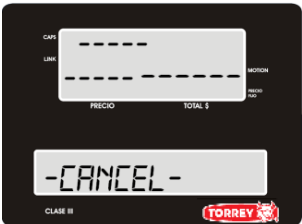

Cancellation: You can cancel a product creation at any time, using the arrow pad to go to the cancel option.
Once selected customer only will have to press ENTER.

12.2.- EDIT A PRODUCT.



1.- To edit a product get into the "Edit Product" option and follow section 12 steps.

1.1.- Press ENTER to get into the option.



You will only use the arrow keys to move around the options.

ENTER key and the red-letter C.



2.- The screen will show the assigned code and product name, you can choose a product to edit with the arrow keys you and then ENTER to begin editing.

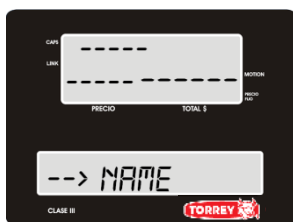

3.- To modify a product's name press:



3.1- After editing a product's name press:

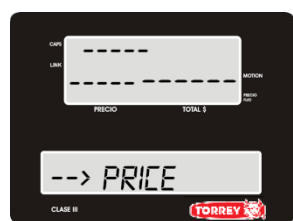

4.- To edit price press:

ENTER

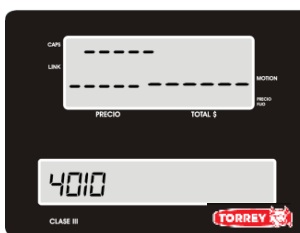

4.1.- To erase a price press the red-letter C.

4.2.- Type the price not higher than 999.99 and then press ENTER.

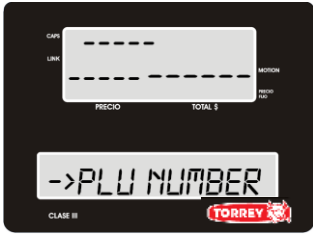

5.- To edit
PLU numbers press
key: ENTER

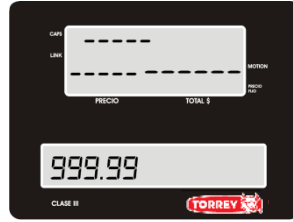

5.1.- To erase a PLU number
press the red-letter C

5.2.- Type the new code



8.- To edit a product's type
press:

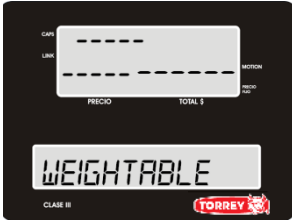

8.1.- Choose the option you'd like to
edit with the arrow keys and then
press ENTER.

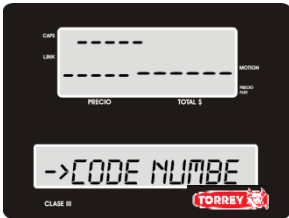

9.-The ID code is not
editable,

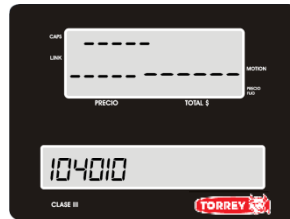

9.1- To go back to the edit
menu press:

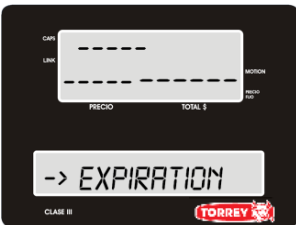

10.- Enter key:
ENTER. Expiration
shall be expressed in
days

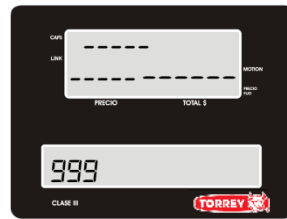

10.1- Enter the number of days.
(from 1 to 999)
The product will be fit for
consumption

Wait a few seconds while the
scale saves changes, and once
it's done it'll go back to the sub
menu.

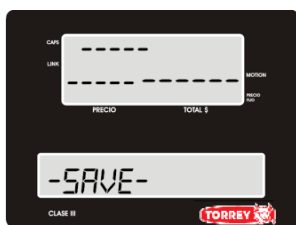

11.- To save changes press ENTER

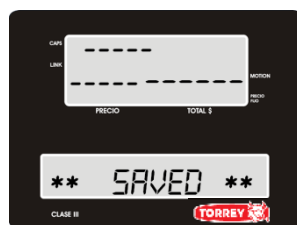

11.1- Wait for a few seconds till the scale finishes saving changes and you will be thrown back to the submenu



CANCEL: To cancel a product changes use the arrow keys to go to the cancel option and press ENTER.

12.3.- DELETE A PRODUCT.

1.- To delete a product go into the option "DELETE PRODUCT" and follow section 12 steps.



1.- Get into the option pressing ENTER



2.- Product's code and name are shown in the menu and can be watched by moving around with the arrow keys and once you select.



a product to delete press ENTER.



3.- The scale will prompt you "are you sure you want to delete this product?"



3.1.- If so press ENTER.

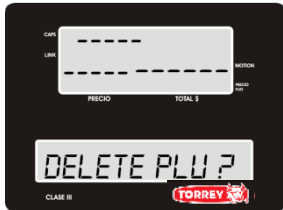

3.2.- if you wish to cancel deleting a product press the red-letter C.



13-RED SETTINGS.

The network option helps you choose the network type of your scale for connectivity with third party apps.

1.- Go into the NETWORK menu option from the main menu configuration p 14.

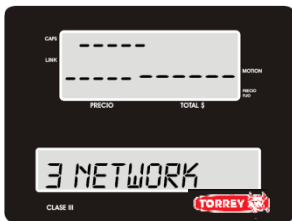

2.- With the arrow keys select the options



3.- Then press ENTER.



Once in you can find the following options: Network Info, Connection Type and Settings. You can choose any of these options moving with the arrow keys. And then press



ENTER



13.1.1- WIFI INFO.

In this option the scale will show you the WIFI information regarding the type of connection.

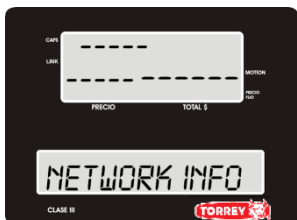

1.- Follow section 13 instructions and select NETWORK INFO.



2.- Press ENTER to get into the Sub Menu.



And with the arrow keys you can watch the Network information complete such as:

(WIFI, STATUS- CONNECTED / DISCONNECTED, RED- SCALE_LINK_#, IP#, MASK#, GATEWAY-#).

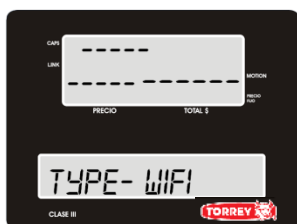

WIFI: On this type of connection the scale can connect wireless by an access point (modem) to a network defined by the user.

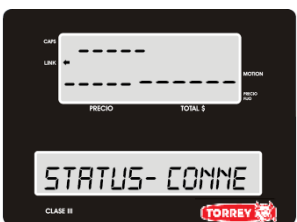

Indicates if the scale is connected to the network defined previously.

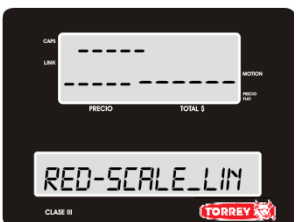

Name of the Network the scale generates for you to connect to it like:

RED-SCALE_LINK

The network name can vary depending on the user's configuration.



Shows the IP Address of the scale.

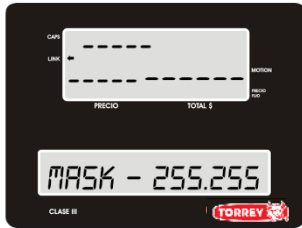

Shows the Network MASK.

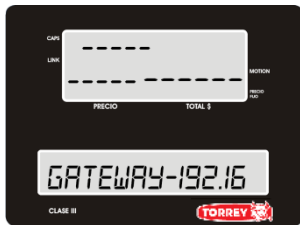

Shows the scale's data gateway.

13.1.2. ETHERNET INFO.

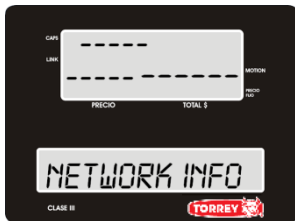

Into this option you will see the Ethernet option.

1.- Follow section 13 steps and select Network Info

2.- Press ENTER to get into the menu. And with the arrow keys to see the different options that it has such as:(ETHERNET, STATUS-CONNECTED/ DISCONNECTED, RED- SCALE_LINK_#, IP#, MASK#, GATEWAY-#).

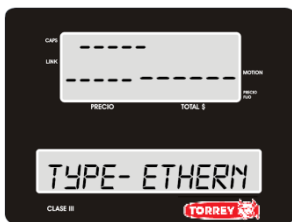

ETHERNET: This connection uses a cable type RJ-45.

Connecting to an access point.



Shows the scale's IP.



Shows the Network's MASK.

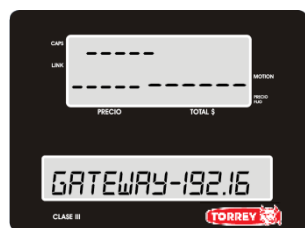

Shows the scale's Gateway.

To be out of the menu just press the back button 4 times.



13.1.3- NETWORK INFO ADHOC <HOT SPOT>

Inside this option you're able to see the whole network information of ADHOC Connection.

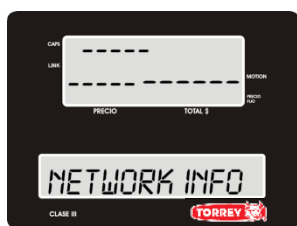

- 1.- Follow section 13th steps into this option.
- 2.- Press ENTER to get into this menu option.



And move around with the arrow keys You'll see parameters such as: (TYPE-ADHOC <HOT SPOT>, STATUS- CONNECTED/ DISCONNECTED, RED- SCALE_LINK_#, IP#, MASK #, GATEWAY-#).

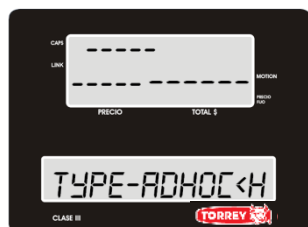

TYPE-ADHOC <HOT SPOT>

This kind of connection allows you to connect to the scale since the scale is acting as a hot spot and you can connect from an iOS/Android Device.

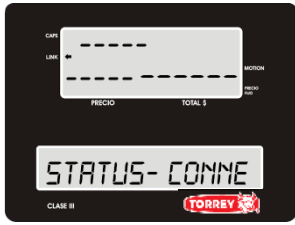

Indicates if the scale is connected to a device.

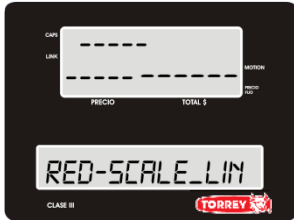

Network name the scale generates automatically.

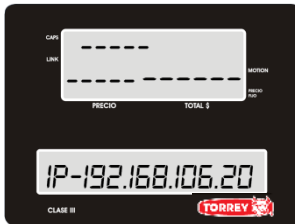

Shows the IP address of the scale.



Shows the Network Mask.

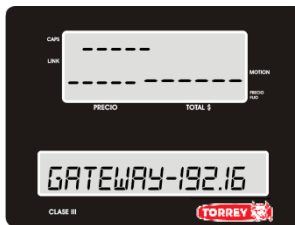

Shows data gateway of the scale.

To be off the menu just press the back button 4 times.



13.2.- TYPE OF CONNECTION CONFIGURATION.

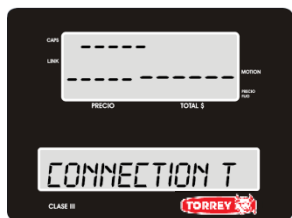

1.- Follow section 13 instructions to know your way into this menu.

1.1- Press ENTER to get into the menu. And move around with the arrow keys to see all the different options:

WIFI (Only for scales with WIFI antenna) ETHERNET, ADHOC <HOTSPOT>, to get into any of these presses ENTER.



The WIFI connection is done wirelessly between the scale, a modem and a computer. The computer should always connect with a network cable to the modem.

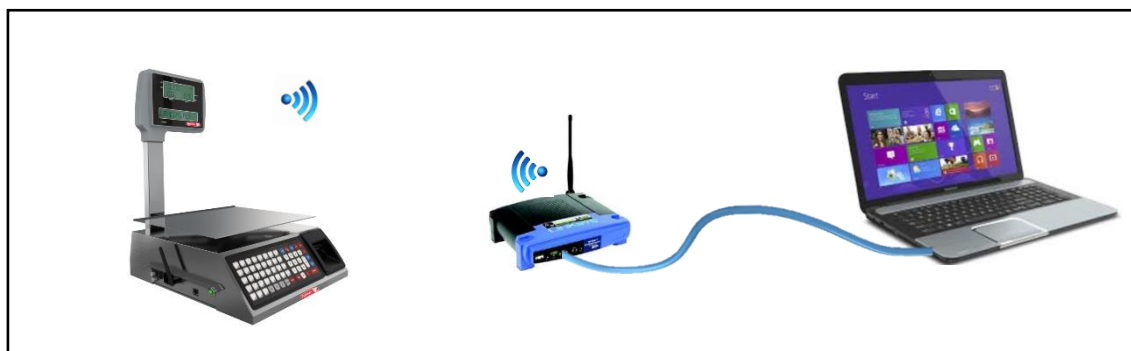

The ETHERNET connection is made with a network cable (RJ45) where you connect a modem, the scale and a computer

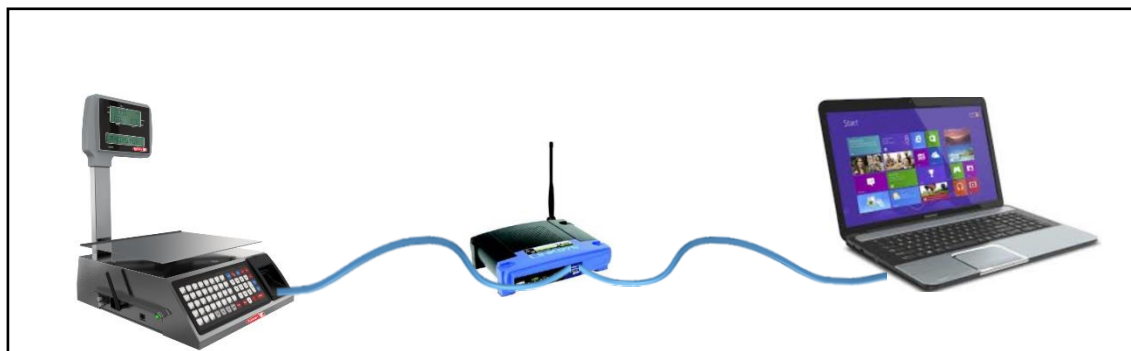

The Adhoc <Hot Spot> connection is made between the scale, and a mobile device in the absence of modem.



13.2.1.- WIFI CONNECTION CONFIGURATION.

(Only for Scales with WIFI Connectivity Available).

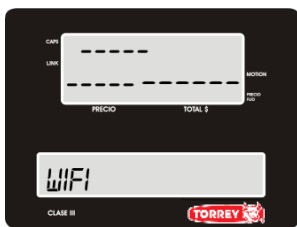

1.- Follow section 13th steps and then select WIFI by pressing ENTER.

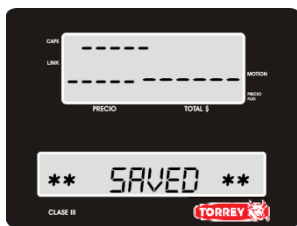

2- Wait a few seconds while the scale configures this option and saves changes, once it ends it goes automatically into the "Look for network" option but if you wish you can use the arrow keys to select for advance settings.



2.1- Once you're into this option and press ENTER the scale will start looking for a network available around it. Once it finishes looking it will make a Beep sound to advice you of the result list on the screen which you can look for the network with the arrow keys.



2.1.1.- To look for the WIFI connection of your preference scroll down the list of networks available using the arrow keys and once you find the right one press ENTER.

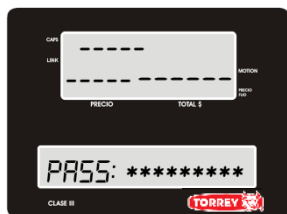

2.1.2.- Type the WIFI password and once you finish press ENTER Use the following keys:



CAPS to change from Capitalized words to normal,
DEL or C to erase characters.



BACK to go back to previous menu option.

In case of error on password the screen will show:

** INVALID**

and 2 seconds after you'll be back into the WIFI network list, in this case repeat 2.1.1 and 2.1.2 of this section **13.2.1 WIFI connection configuration p. 29.**



Once you accomplish filling WIFI fields correctly the screen will show:

"CONNECTING PLEASE WAIT"



Scale will reboot after a successful connection.

After rebooting the scale will be back into the submenu NETWORK INFO

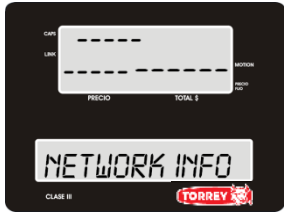

Once you press ENTER, you'll be able to see the network characteristics already established:



Network Type, Connection Status, Network Name, IP Address, Network Mask, Gateway.

The connection indicator on the scale should be active by now, see reference **(5.1, P. 10)**.

13.2.2.- ETHERNET CONFIGURATION.

Connect the scale to a router by a RJ-45 cable.

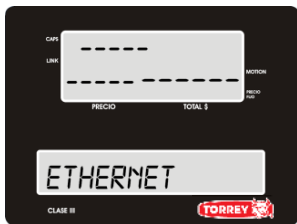
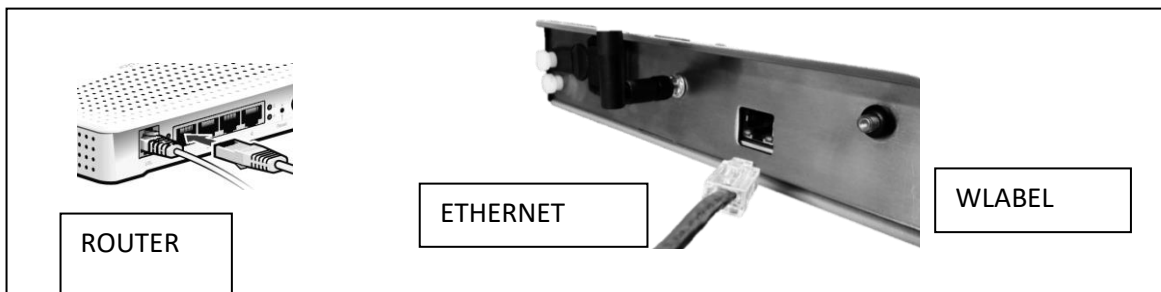

1.- Follow the steps of section 13.2 Type of connection configuration P.28 and choose ETHERNET

by pressing the ENTER key.

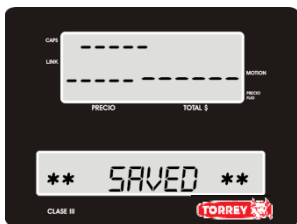

2.- Wait a few seconds while the scale configures this option and saves changes, once finished, it goes automatically into the sub-menu Configuration.

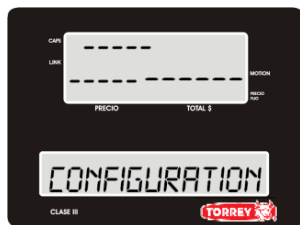

3.- The connection indicator goes active, see reference (5.1, p. 10)



Press ENTER to get into the configuration parameters.

Once inside, by the arrow keys you can choose between the IP options, DINAMIC IP and STATIC IP.

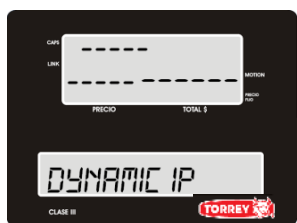

3.1.- When choosing DYNAMIC IP, the scale configures automatically the necessary parameters for it to work dynamically on the scale.



3.1.1.-Once done show reboot by

***READY**



3.1.2.-The scale will It will itself

and go into

CONFIGURATION.

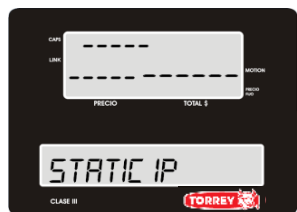

3.2.- When choosing STATIC IP, it should assign it's IP automatically, it'll show the message Type IP



3.2.1.- By default the IP address is 192.168.106.20 with the arrow keys you can move around it's address and modify it.

To erase a digit, press the DEL key or the C key, once finished editing the IP address press ENTER, then it will show the message Type in Network Mask.

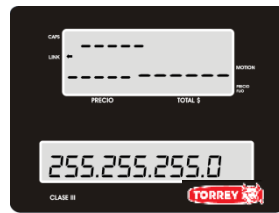

3.2.2-. By default, the network mask is 255.255.255.0 using the arrow keys you can move around the digits, you will notice your current position due to the digit blinking when selected, you can replace the digit with a

different one with the number pad. To erase a digit, use the DEL key or the C key, once finished editing the network mask press ENTER, it will show a message TYPE GATEWAY.

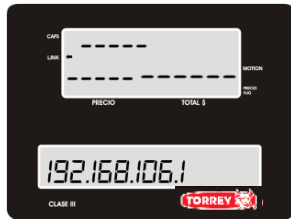

3.2.3-. By default, the gateway is 192.168.106.1 you can move around the digits using the arrow keys, you will notice your current position on the digits due to the certain digit blinking you can replace that digit using the numbers pad. To erase a digit,

use the DEL key or the C key, once finished editing press ENTER, then it will show the following messages:

WAIT SAVING IP.

IP UPDATED.

RESTARTING.

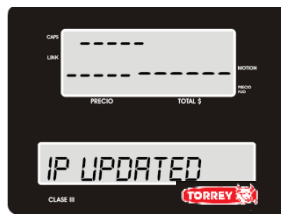

13.2.3.- ADHOC <HOT SPOT> CONECTION CONFIGURATION.



1.- Follow the steps on section 13.2 type of connection configuration P.28 and choose ADHOC <HOT SPOT> by pressing ENTER.

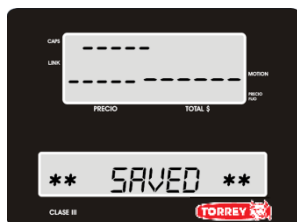

2- Wait a few seconds while the scale activates this function and saves changes, once done, it goes automatically into SETTINGS.

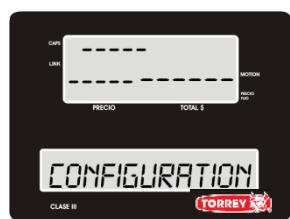

3.- The connection indicator will go off, see reference (section 4.1 p. 10). Press ENTER to go into the parameters of this option.



Once in move around with the arrow keys



You can choose between NETWORK NAME, NETWORK PASSWORD, INITIATE, ADHOC. Choose one by pressing ENTER.

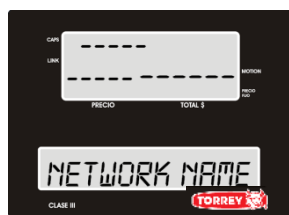

3.1.- Once you press ENTER the scale will show the network name so that you can connect to it by a mobile device or pc.

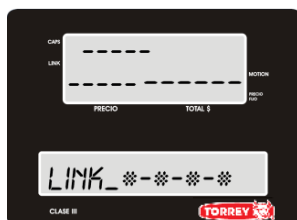

3.1.1.- The visible network for mobile devices and pc(wirelessly) will start with the words SCALE_LINK_ followed by a unique alphanumeric code. *It is recommended not to alter this code.*

Using the arrow keys, you can move around the digits, and replace a digit with the numeric pad.



To erase a digit, press the DEL key or the C key once finished editing the network name press ENTER and it will show NETWORK PASSWORD.



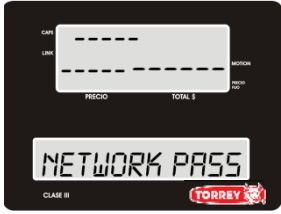

3.1.2.- Press ENTER to place an 8-character long password

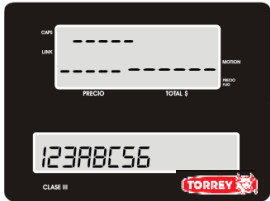
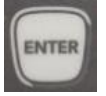

3.1.3.- You can use letters and numbers on this one. The CAPS key allows you to go from capitalized letters to normal and vice versa,



You can erase characters by using the DEL key or the C key, With the arrow keys you can move around the digits.



Press ENTER to go into the next section.

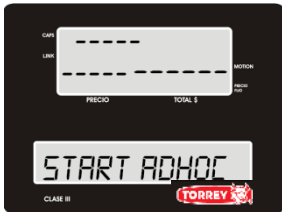

3.1.4.- Press ENTER to save the established parameters. Once the scale saves the changes it will show you the progress in 3 steps.

The messages you'll spot are:

WAIT.

CONFIGURING.

READY.

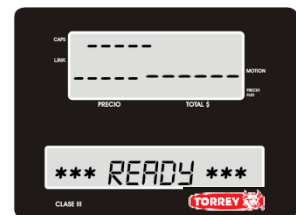
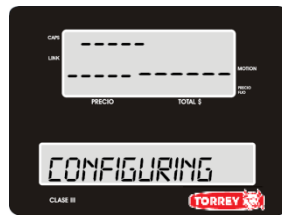
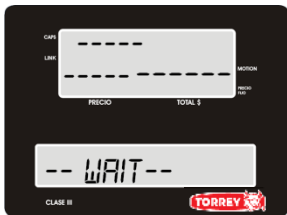

Once it finishes saving the information, it'll go back to the NETWORK menu option, to out the menu press the RETURN key 3 times.



14.-PRINTER CONFIGURATIONS.

Inside this option you can configure the automatic printing and the contrast of printer on labels or tickets.

1.- Go into the SETTINGS menu option following the steps of section 7 p. 14

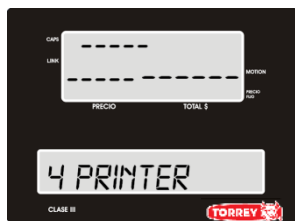

2.- With the arrow keys select



4 PRINTER and press ENTER



Inside this menu you can find the options: AUTO PRINT, CONTRAST

Choose any of the options with the arrow keys and press ENTER to

select it



14.1.- AUTO PRINT SETTINGS.

AUTO PRINT is a label exclusive option, this function saves you time packing a product.

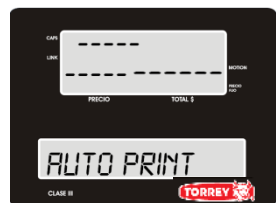

1.- Follow the steps on section 14 type of connection configuration P.33 and choose AUTO PRINT by pressing ENTER



2.- Press ENTER to go into the option. And with the arrow keys you can see the parameters ENABLED, DISABLED.



Press ENTER this will save changes.



3.- Once it finishes saving changes, it will take you to the previous menu and you can be off the menu by pressing the RETURN key 3 times.



14.2.- PRINTER CONTRAST SETTINGS.

On this option you can configure the printer contrast.

Level 1 it's the clearest and level 10 it's the darkest.



1.- Follow section 14 steps P.33 and choose CONTRAST.



2.- Press ENTER to go into this option and by using the arrow keys you can go onto the contrast levels.

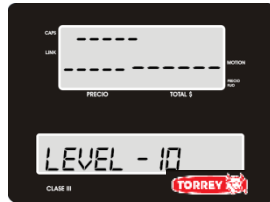
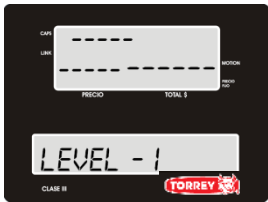

By default, the intensity level is 7 the raise of level can slow down the printer.



Press ENTER to save changes, once done the scale will take you to the previous menu option, to be off the menu just press the RETURN key 3 times.



LEVEL 1

LEVEL 5

LEVEL 10

NOTE: It's recommended to use level 7 of contrast.

15-DATE AND TIME SETTINGS.

This menu option will help you be synchronized with your business and it makes it easier to manage a business.

1.- Go into the menu option 5 DATE AND TIME by following section's 7 steps p. 14

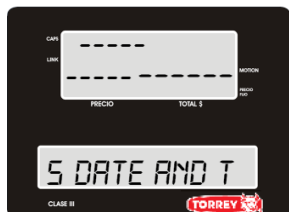

2.- Using the arrow keys select the option



5 DATE AND TIME, and press ENTER

Inside this menu you can find the following options: SEE DATE AND TIME, SET DATE, SET TIME, DATE FORMAT, TIME FORMAT.



Select any of this option moving with the arrow key and press ENTER to get into the option.



15.1.-SEE DATE AND TIME.



Shows date and time saved on scale's memory.

1.- Follow section 15 steps P.36 and choose the option SEE TIME AND DATE.



2.-Press ENTER to go into this option.



The display will show the current date and time of the scale. To be off the menu just press the RETURN key 4 times.

15.2.- SET DATE.

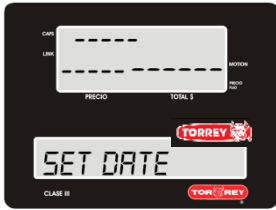

This menu option allows you to configure the date on your scale.

1.- Follow section 15 steps P.36 and choose SET TIME.



2.- Press ENTER to go into this option.

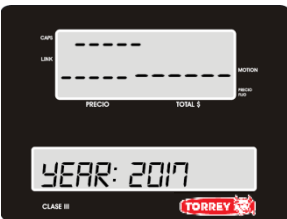

3.- You can move around the digits with the arrow keys.



Use the numeric pad to replace characters and to delete a digit press the DEL key or the C key.



Once you're done editing press ENTER to save your year and go to month.

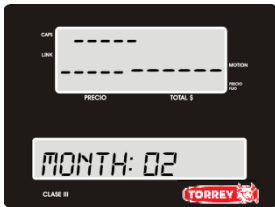

4.- Use the arrow keys to move around the digits and replace any of the digits with the number pad or press the DEL key or C key to erase a digit.



Once you're done with the month press ENTER to go to DAY.



5.- Use the arrow keys to move around the digits and replace any of the digits with the number pad or press the DEL key or C key to erase a digit. Once you're done with the month press ENTER to save the parameters.

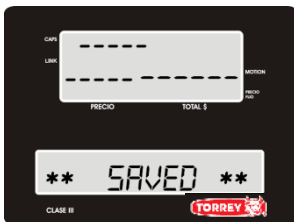

Once the parameters are saved, to be off the menu press the return key 4 times.



15.3.- SET TIME.

This menu option allows you to set the time on the scale.

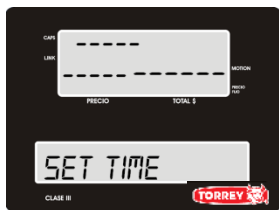

1.- Follow section 15 steps P.36 and choose SET TIME.

2.- Press ENTER to get into this option.



3.- Use the arrow keys to move around the digits and replace any of the digits with the number pad or press the DEL key or C key to erase a digit.

Once you're done with the month press ENTER to go to minutes.



4.- Use the arrow keys to move around the digits and replace any of the digits with the number pad or press the DEL key or C key to erase a digit.

Once you're done with the month press ENTER to save parameters.



Once the parameters are saved, to be off the menu press the return key 4 times.



15.4.-DATE FORMAT SETTINGS.

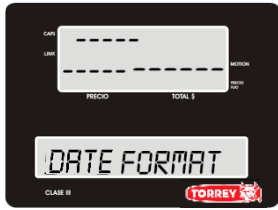

This menu option allows you to change the date format shown on scale. (MM/DD/AAAA or DD/MM/AAAA)

- 1.- Follow section 15 steps P.36 and choose DATE FORMAT.
- 2.- Press ENTER to get into this option.

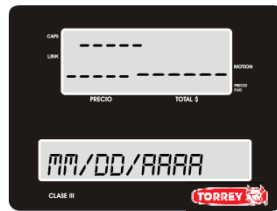

- 3.- Choose the format you like the most with the arrow keys and press ENTER to select it, the scale will save this selected format.



Once all the changes are saved press the return key 4 times to be off the menu.



15.5.- TIME FORMAT SETTINGS.

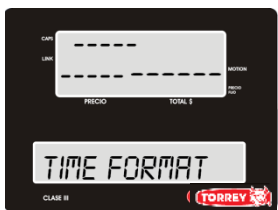

This menu option allows you to change the time format of the scale. (24 HRS or 12 HRS AM/PM)

- 1.- Follow section 15 steps and choose TIME FORMAT.
- 2.- Press ENTER to go into this option.

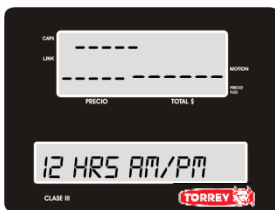

- 3.- Choose the format you like the most with the arrow keys and press ENTER to select it, the scale will save this selected format.

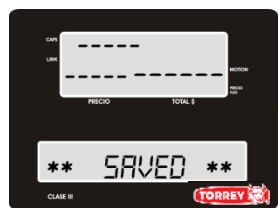

Once you've done making changes on the format you can be off the menu by pressing the RETURN key 4 times.



16.-MEMORY SETTINGS.

The memory settings allow you to erase products end sales.

1.- Get into the 6 MEMORY menu option following section 7 steps p. 14

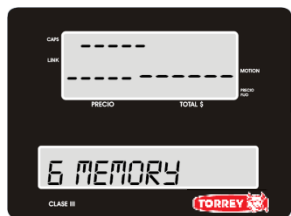

2.- With the arrow keys go to 6 MEMORY and press ENTER to go into it.

Inside this menu option you can find the following options: DELETE SALES, DELETE PRODUCTS,



DELETE EVERYTHING. Choose any of the options navigating with the arrow keys and pressing ENTER.



16.1.- DELETE SALES.

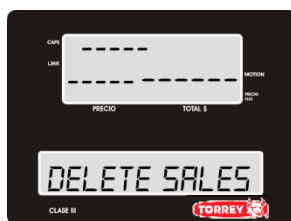

This option erases all the sales done on the scale.

1.- Get into the 6 MEMORY menu option following section 7 steps p. 14 choose DELETE SALES.

2.- Press ENTER to get into this option.



3.- The scale will show a message saying:

DO YOU WISH TO DELETE ALL THE SALES?

If you want to cancel this operation press the return key or the C key.

Press ENTER to erase all the sales.

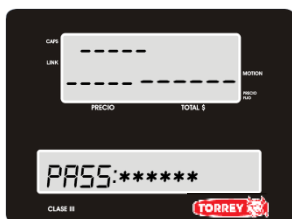

4.- The scale will ask you for the password of the scale.

The scale reboots and goes off the menu.

16.2.- DELETE PRODUCTS.

This option allows you to delete all the products saved in the scale's memory.



- 1.- Get into the 6 MEMORY menu option following section 7 steps p. 14 and choose DELETE PRODUCTS.
- 2.- Press ENTER to go into the option.



- 3.- The scale will show you a message saying: DELETE ALL PRODUCTS?
If you want to cancel this operation press the RETURN key or the C key to go back.

Press ENTER to confirm and erase all the products.

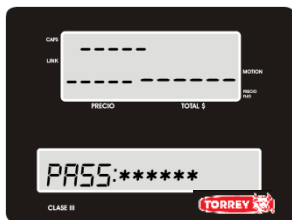

- 4.- the scale will ask you for the user's password and then it'll begin erasing all the products on the scale.

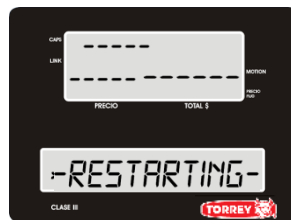

- 5.- Once it finishes this operation the scale will produce an alert sound to advice you of the process.

16.3.- DELETE ALL.



It allows you to DELETE all sales and products saved in the scale's memory.

- 1.- Follow section 15 steps P.36 and choose DELETE ALL.
- 2.- Press Enter to get into this option.





3.- the scale will show a message saying:
 DO YOU WISH TO DELETE EVERYTHING?
 If you wish to cancel press the return key or the c key.
 Press ENTER to confirm and initiate the process.

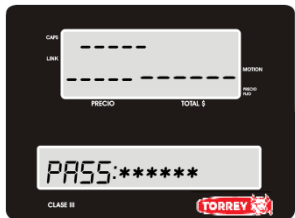

4.-The scale will ask you for the user's password (usually 123456) to proceed with the operation.

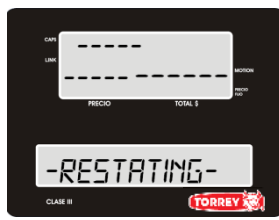

5.-After erasing all data from scale it will reboot and take you to the main screen.

17.-LANGUAGE SETTINGS.

This option configures the menu language, home screen remains the same.

1.- Follow section's 7 steps p. 14

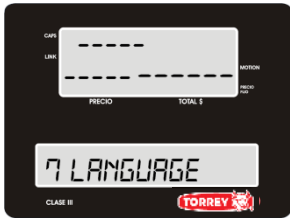

2.- Using the arrow keys go to Language and press ENTER

On this menu option you will find the following selections: Spanish, English.

Choose any of these with the arrow keys and press ENTER to select.

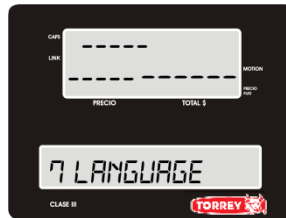
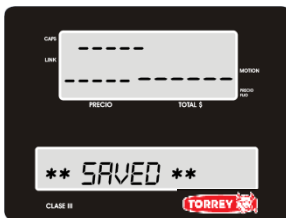
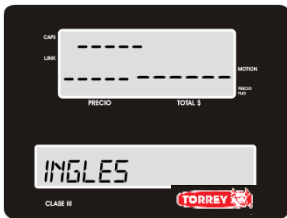

3.- Once it's saved the menu will appear in the language selected previously, and you can go off the menu pressing the

RETURN key 2 times.

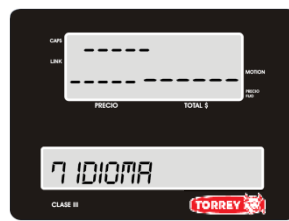

4.- When choosing Spanish the screen will show the following message:

****GUARDADO****,

automatically the whole

menu changes to Spanish. Once all the changes are done you can be off the menu by pressing the RETURN key 2 times.



18.-SCALE INFORMATION.

1.- Follow section 7 steps to go into this option p. 14

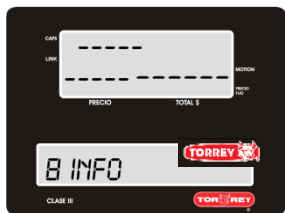

2.- With the arrow keys go the 8th option and press ENTER.

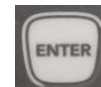

Inside this menu option you can find the different messages: SERIAL NUMBER, SOFTWARE VERSION. Choose any of the options moving with the arrow keys and pressing ENTER to desired option.

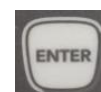

3.- When choosing SERIAL NUMBER, the display will show the serial number on display and this number can't be altered by the user.



4.- -when choosing FIRMWARE VERSION, the scale shows the version on display and this parameter it's also uncapable to be altered by the user.

To go off the menu press the RETURN key 3

19.- SCALE'S OPERATION

19.1.- ADJUST TO ZERO.

To assure the new zero reference make sure the scale doesn't have any weight on it and press the CERO key:



19.2- TARE FUNCTION.

Tare function is used when a product has a container that adds weight to the product. To use this function, place the empty container on the plate and press:



The weight display will return to zero and the ZERO and NET indicators will be activated, from this moment you can begin to place weight inside the container.



If you remove the container from the plate, the scale will show a negative value.



To deactivate the tare function just press the TARE key again and the indicators ZERO and NET will go away.



19.3.- AGENT SELECTION.

To select an agent from the scale, press the VEND key on the scale's keyboard



and it will show a menu that shows the agents list:



Use the arrow keys to move around the list and press ENTER to select the agent on the scale.



When selected the scale will go back to the main Screen and show the agent's name on the display for 3 seconds.

19.4.- FIXED PRICE SELECTION.

This option is used to pre-pack a product.



1.-Choose the product you wish to pre-pack or type in the name and Price of the product



2.- Once the fixed Price is pressed the indicator of Fixed Price will go on.



Put the weight of the product n the plate and then



Press PRINT the Price will remain static and the only thing you are able to change is the weight.



To be off the function just press the FIXED PRICE button again. By doing this the indicator of this function goes off.

19.5.- PAPER FEED.



This function allows you to have a portion of the paper or a label in blank.

To activate this function just press the ADVANCE PAPER button and the display will show the NEG indicator.

20.- PLU SELECTION.

Follow section 11 steps p. 18 and choose SHORTCUTS.

Go back to scale's normal functions by pressing the RETURN key 3 times.



By this action the shortcuts saved on the scale get activated. IF you wish to have a PLU on your scale type the code of the product and the press the red

PLU button.



Then on the publicity display will appear the product's name selected by the price per lb.

To cancel the selected PLU just press the red C key twice.



21.- NON-PLU SALE.

Follow section 9 steps p.16. and choose ENABLE.



Go back to the main Screen by pressing the RETURN key 3 times.



Type the non plu name on the scale and press ENTER, once done the new product will appear on the publicity display.



Use the numeric pad to type in the product's Price and then put the product's weight on the plate.

Once done press PRINT on the scale.



To cancel this function, press the red C key on the scale twice to go back to the main Screen.



22.- NON-PLU NON WEIGHTABLE SALE.

Follow section 9 steps p.16. and choose ENABLE.



1.- Get the weight off the scale and use the numeric pad to type in the product's Price on the scale.

Press the PIECES key on the scale followed by the quantity to sale.



2.- Once done this step you'll see the number of pieces on the publicity's display.



3.- Once you type in the number of quantities to sale the scale calculates the total for the customer to pay.

Press the PRINT key on the scale.



To cancel this function, press the red C key on the scale twice.



Once the label has been printed the Screen will go back to its normal state. If you don't want to repeat all the previous steps over and over, you can press FIXED PRICE to work with a single product:



23.- PRODUCT SALE.

23.1.- PRE - PACKING MODE- WEIGHABLE PRODUCTS SALE.

To sale a weighable product you must follow the next steps:



1.- Type in the PLU code in the scale, example 101, followed by the PLY key on the scale.



The publicity Display will immediately show the product's name.

To cancel the sale just press the red C key on the scale twice.



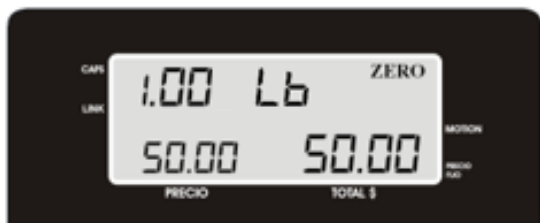

2.- wait till the weight on the scale is stable and the Screen shows 0.000.



3.- If you don't want to repeat the las steps over and over you can press STATIC PRICE to work with the same product and price:



23.2.- PRE-PACKING MODE – NON-WEIGHABLE PRODUCTS SALE.

On non-weighable products sale the scale must have no weight on the plate.

To make this kind of sale follow the next steps:



1.- Type in the product's code n the scale using the numeric pad followed by the PLU key on the scale.



The publicity display will immediately show the product's name, quantity and Price, if you only wish to sale a single piece press PRINT on the scale.



To cancel the sale, press the red C key on the scale twice.



2.- To increase the number of pieces to sell press the X key on the scale followed by the number of pieces to sell then press PRINT



To cancel this function, press the red C key on the scale twice.





3.- Once the sale is made the scale will go back to the main Screen. If you don't want to go over these steps several times you can always use the FIXED PRICE:



23.3.- PRE-PACKING MODE – SELL OF SEVERAL WEIGHABLE PRODUCTS.

To sell several products you must follow these steps:

Follow section 11 steps p. 18.



1.- Type the non plu name on the scale and then press ENTER then the display will show the product's name on the publicity display



2.- Type in the Price of the new product and then place the product on the scale's plate, if you remove the weight off the scale the scale will go back to zero and the product's information would be gone.

Wait for the product to be steady on the scale and the ticket will be printed automatically, (if the auto-print function gets activated).



3.- In case of auto-printing isn't activated press the red button PRINT.



To cancel or delete a product, just press twice the red key C.



4.- Once the label has been printed, the scale's display will go back to normal. If you don't want to go around this step over and over press STATIC PRICE:



23.4.- PRE-PACKING MODE- SALE OF NON-WEIGHABLE NON-PLU PRODUCTS.

To sell a non plu non weighable product you must follow the next steps:

Follow section 11 steps p. 18



1.- Press the red button PIEZAS and type the product's price press the X key and type the number of pieces of the product.



Lastly press PRINT



To cancel press the red C key twice.



Item pz will appear on the display.

23.5.- POINT OF SALE MODE – WEIGHABLE AND NON-WEIGHABLE PRODUCTS SALE.

To sell several products at once and mix products by their weight or by piece follow the next steps.

Follow section 8.2 steps.



1.- Type the code assigned to the plu example 101, once done the display will show the product's price, after this press PLU. And place the product on the scale to get the



weight.

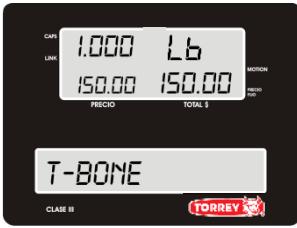

2.- The display will show Price and weight right away.

Press the plus button and do the first step again for the next plu.



Doing this several times the scale shows you the number of item's you're selling and the total price.



The same function applies to sell by quantity after typing the product in and pressing the X key and number of pieces to sell.



Once done with the sell press PRINT to get the new ticket.



Same steps apply to non plu products by just pressing the plus key after typing the product into the scale.



Also, for non plu non weighable products, just type the new product in followed by the X key and the number pf pieces to sell.



To cancel the operation just press the red C key twice.

24.- APPLY DISCOUNTS.

This function allows the user apply discounts to the products they're selling:



To apply a discount there must be at least 2 products on list to sell.



Press the -D/DEV PLU key.



By using the arrows keys, you can either choose the discount to apply or select to cancel the sale.



On both cases press ENTER to finish the operation.



Choose with the arrow keys the product you want the discount to be applied maximum of 99% and press ENTER.



Then press the percentage to be applied on the sale.



And press ENTER.

Type on the password and then press ENTER for the discount to be applied, once done this, the scale will show the discount at the end of the sale on display.

To finish the operation, press the PRINT key to get the ticket with the sale and discount already applied on it.



Note: The discount applies only to products not to the total to pay.

25.- RETURNS.

This operation allows you to make returns of a product before been charged to the customer are vent after been charged.

25.1 IMMEDIATE RETURN.

To make an immediate return follow these steps:



To apply this function on the scale there must be at least a product n list to sell and not been charged yet or printed the ticket of the sale.



Press the -D/DEV.PLU key



With the arrow keys choose return, if you do not wish to apply this function choose cancel sale.



Either way press ENTER at the end.



By moving with the arrow keys choose the product you would like to return, and press ENTER

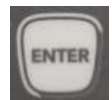

Type in the password and after pressing enter the scale will change the total amount of sale.

To make several returns follow the same procedure.

Lastly press the Print key to print the ticket with the return functionality plied already.

25.2 LATER RETURN

To apply this return there must be at least a product in the list of the sale and it should be charged to the customer already.

To achieve a later return, follow these steps:



Place the product on the scale.



Type in the plu number of the product to be returned.

And press -D/DEV.PLU afterwards



Immediately type in the password and press ENTER for the return to be applied.



The display will show the following message after pressing ENTER: "Successful Transaction" for a few seconds.

Then the scale will be back to the main screen.

26.- CHANGE OPERATION (TICKET).

This function allows you to calculate the change to give to the customer.

Once you have the sale ready to be charged to the customer and you need to calculate how much you must give back to the customer follow the next steps:



On the image you have 3 items on the list and a total amount of 493.75, to know how much change you must give press the plus key followed by the blue change button.



The display will immediately show CASH \$ where we must type in the total amount the customer is paying with.



Once you typed the total amount the customer is paying with press ENTER.



You will see the change to give on the display. Press the PRINT key to print the ticket.



In case the amount you typed is less than the total amount of the sale the display will show: CASH MUST BE MORE THAN TOTAL AMOUNT.

27.- SCALE LINK MOBILE APP

With Scale Link Mobile App, you can manage, configure and review sales reports in real-time directly from compatible Torrey's scales.

You can establish a communication with Torrey's scale directly, once the communication has been established, you can use the following functionalities:

MANAGE

- See available product's list from the scale. You can do updates of products such as change prices, assign offers and view additional information.
- Access a section where you can create new products.
- Organize your sender's team.
- Consult offers and additional information's list.

CONFIGURATION

- Keep your customers up to date with publicities messages. You can configure at least 5 messages for publicity which they can see directly in the scale.
- Enable/Disable general settings such as "Autoprint", "Reprint", "Lock Prices", "Allow PLU Returns", "Allow Discounts" and "Allow Non PLU".
- You can manage scale's security password such as "Administrator" and "Supervisor".
- Set date and time format in which will appear within the tickets.
- Customize ticket's headers. You can set custom texts headers for your customer's tickets.
- Change and customize barcode formats to make it compatible with your point of sale.
- Set scale's shortcuts directly from Scale Link's app.

REPORTS

- You can review or export a history of sale's reports directly from your scale in anytime. A report may be reviewed by "Date", "Sender", "Product" and "Scale".

Scale Link Mobile App is available on the following stores:

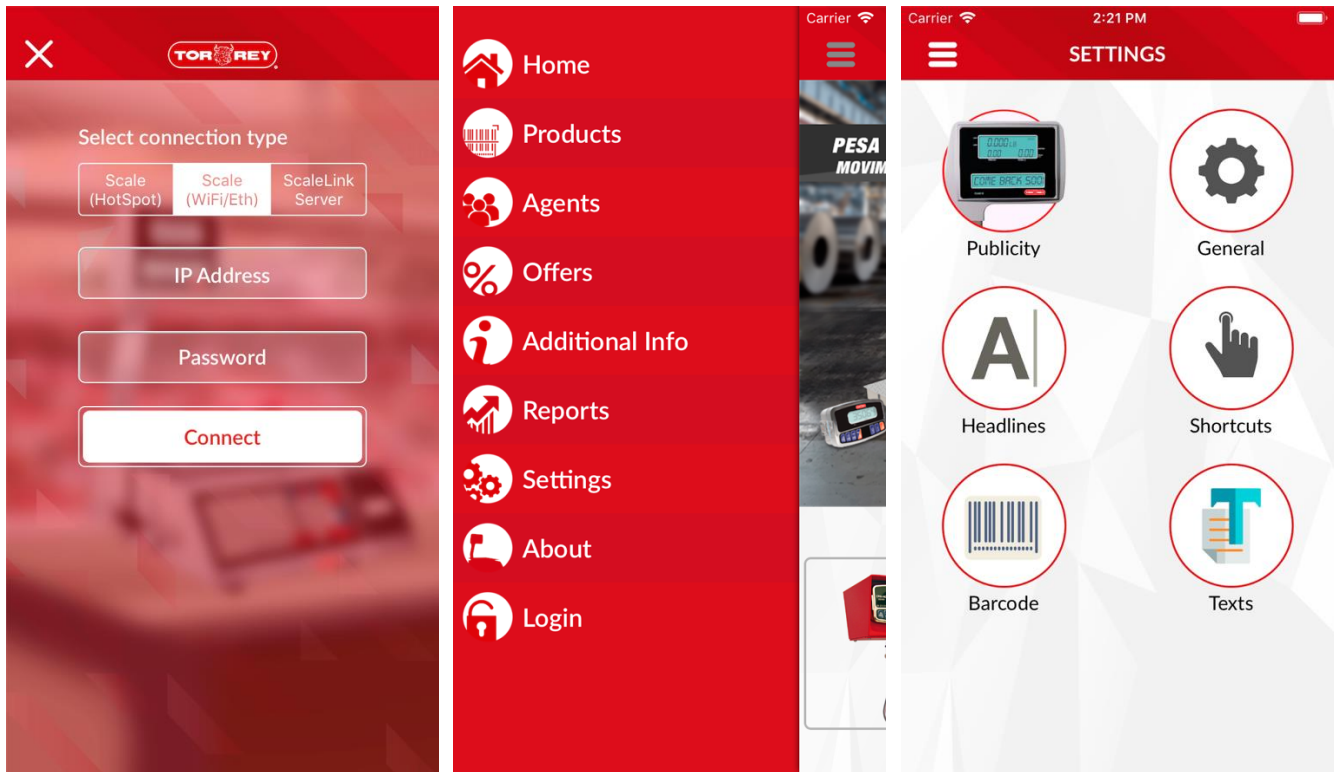

Apple devices requires iOS 10.3 or later. Compatible with iPhone, iPad and iPod Touch.

Android devices requires Android 5.0 or later. Compatible with Android Phone and Tables.

27.1.- SET CONNECTION WITH SCALE.

There are 3 types of connections in which you can set communication between mobile device and scale using Scale Link App.

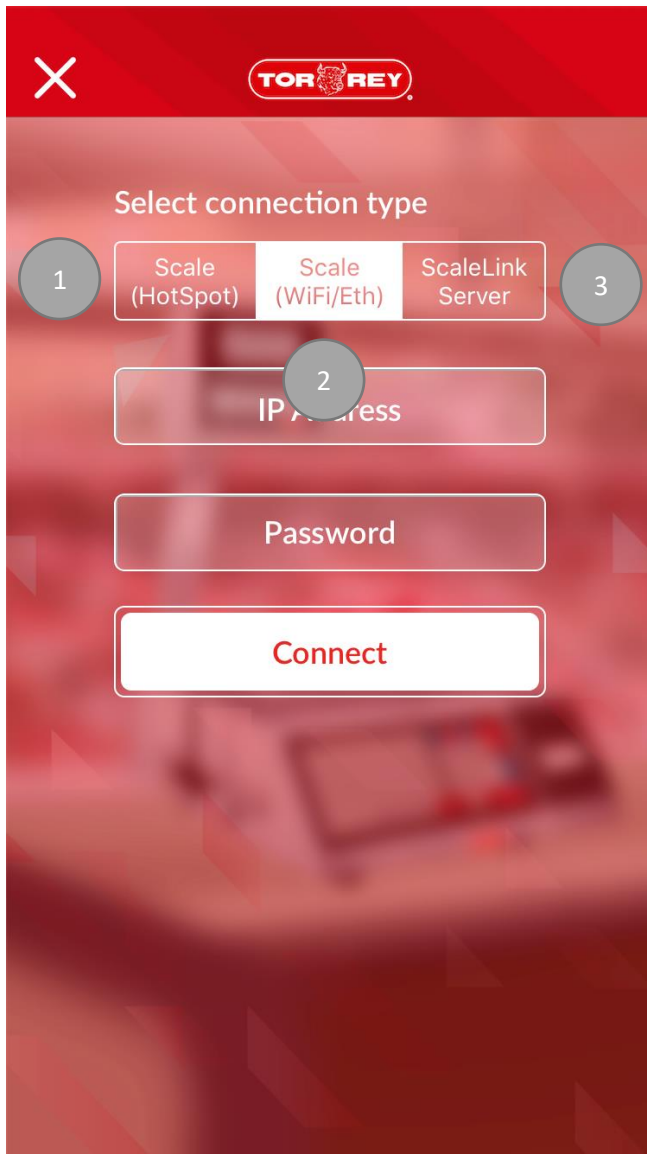

1. HotSpot

The mobile device must be connected to owns scale's network to stablish a communication.

2. Wifi/Eth

The mobile device and scale must be connected to the same network.

3. Scalelink Server

To use this connection type, you have to install Scalelink software on your PC, the mobile device and pc must be connected to the same network. This manual no cover this connection type, for more reference how to use it, you can visit this url: <http://torrey-cloud.com/downloads/>

27.1.1.- CONNECTING USING HOTSPOT.

Before you establish a communication with scale, you need to follow the steps on section 13.2.3 to active and set ADHOC<HOT SPOT> on scale.

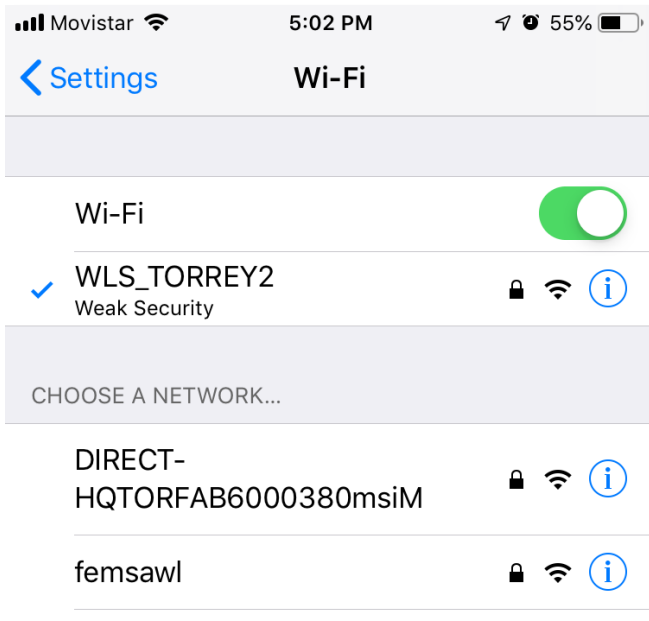

After you configure correctly your scale ADHOC<HOT SPOT>, you need to connect to network that your scale created.

Search and select the network on your mobile device and enter the password has been created. The password must be same you configured in scale's network.

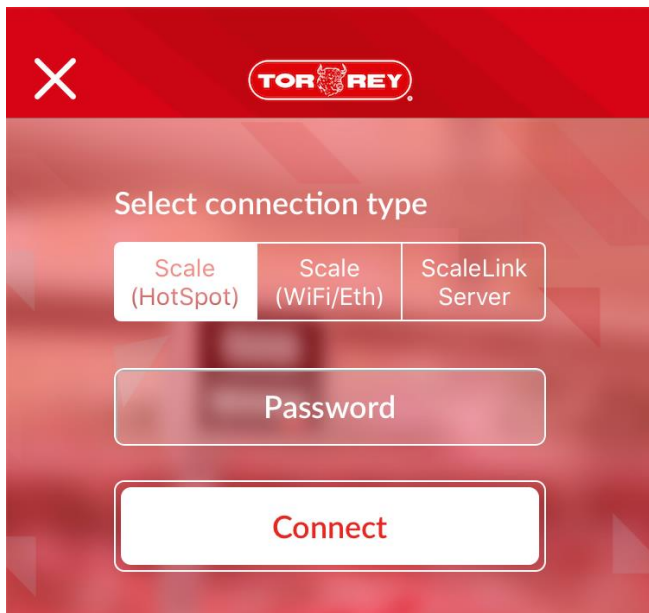

You need return to Scale Link App's menu and press Login then select Scale (HotSpot) option after that you need to enter the scale's password and press Connect button.

Note: If you changed the default scale's password you must enter the new password otherwise the default password is 123456.

27.1.2.- CONNECTING USING WIFI/ETH.

Before you establish a communication with scale, you need to follow the steps on section 13.2.1 – 13.2.2 to active and set WIFI and ETHERNET configuration on scale.

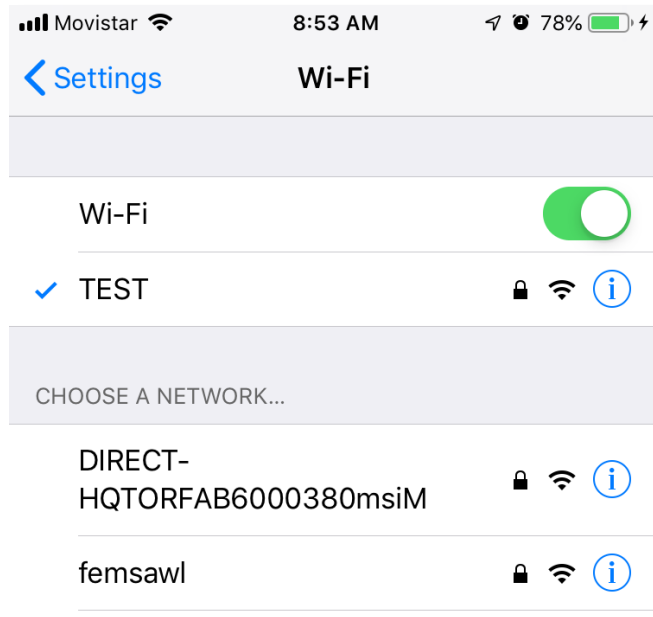

Search and select the network on your mobile device, the network must be the same where scale is connected to.

Note: If you prefer using device data, you need to share your mobile's connection data and connect the scale in the same hotspot mobile has created.

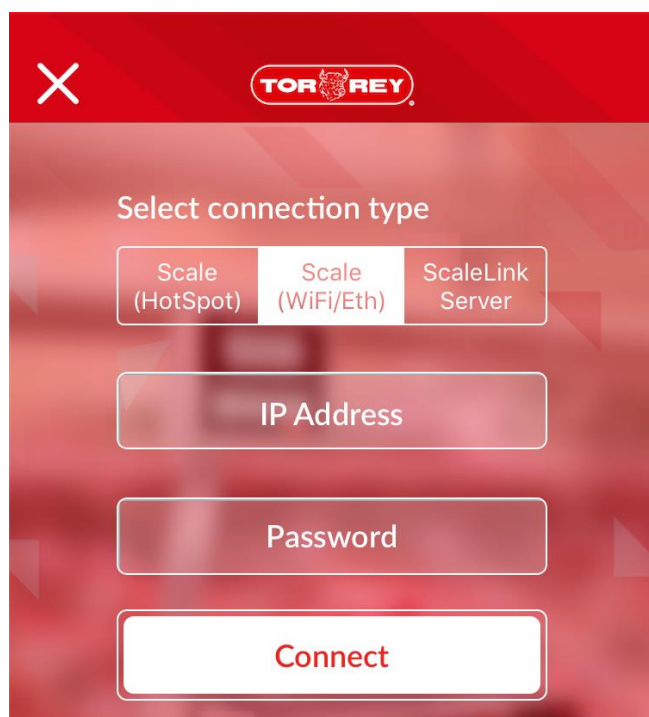

Return to Scale Link App's menu and press Login then select Scale (WiFi/Eth) option and enter IP Address and Password data of your scale configuration. To check IP Address assigned to scale you can go Network Info in scale's menu, please see section 13.1.1 – 13.1.2.

Note: If you changed the default scale's password you must enter the new password otherwise the default password is 123456.

272.- PRODUCT SECTION.

On this section you can view product's list, add and edit products within your scale directly from Scale Link App.

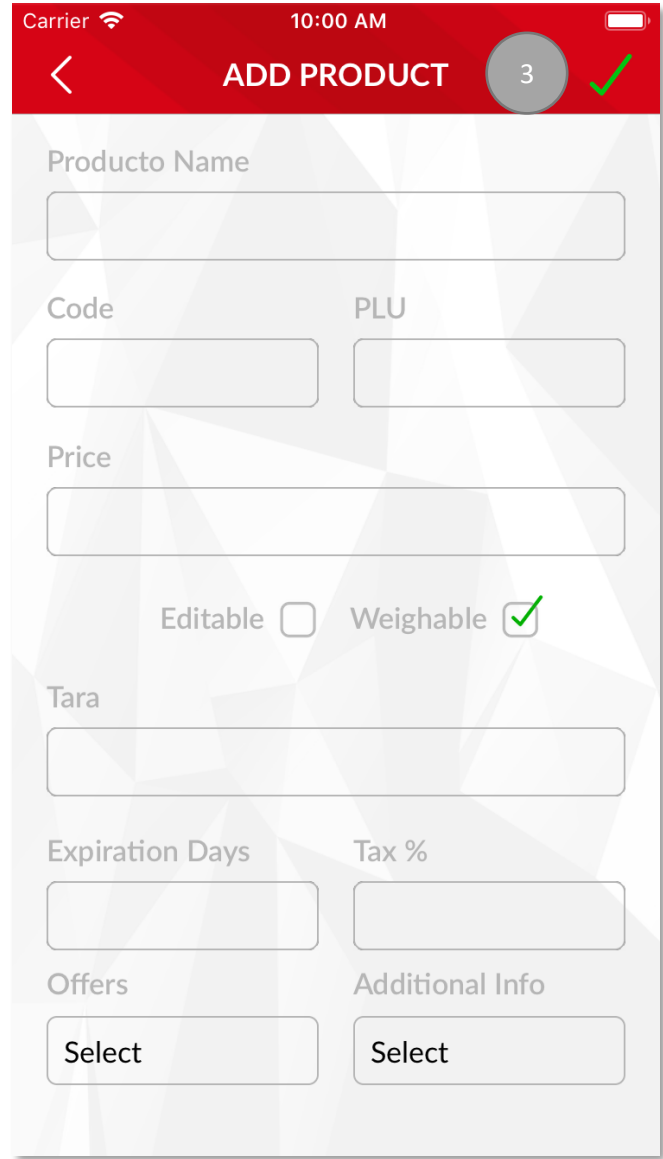
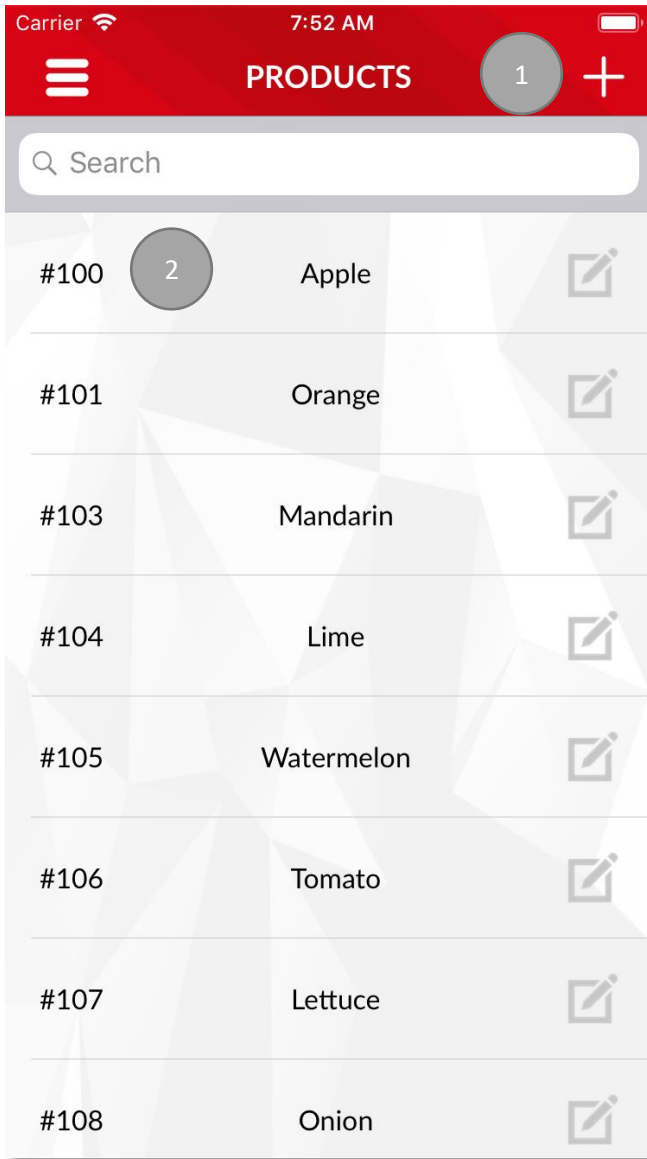

1. For create a new product within your scale.
2. Press on product item to edit it within your scale.
3. For save changes product's data.

27.3.- AGENT SECTION.

On this section you can view agent's list, add and edit agents within your scale directly from Scale Link App.

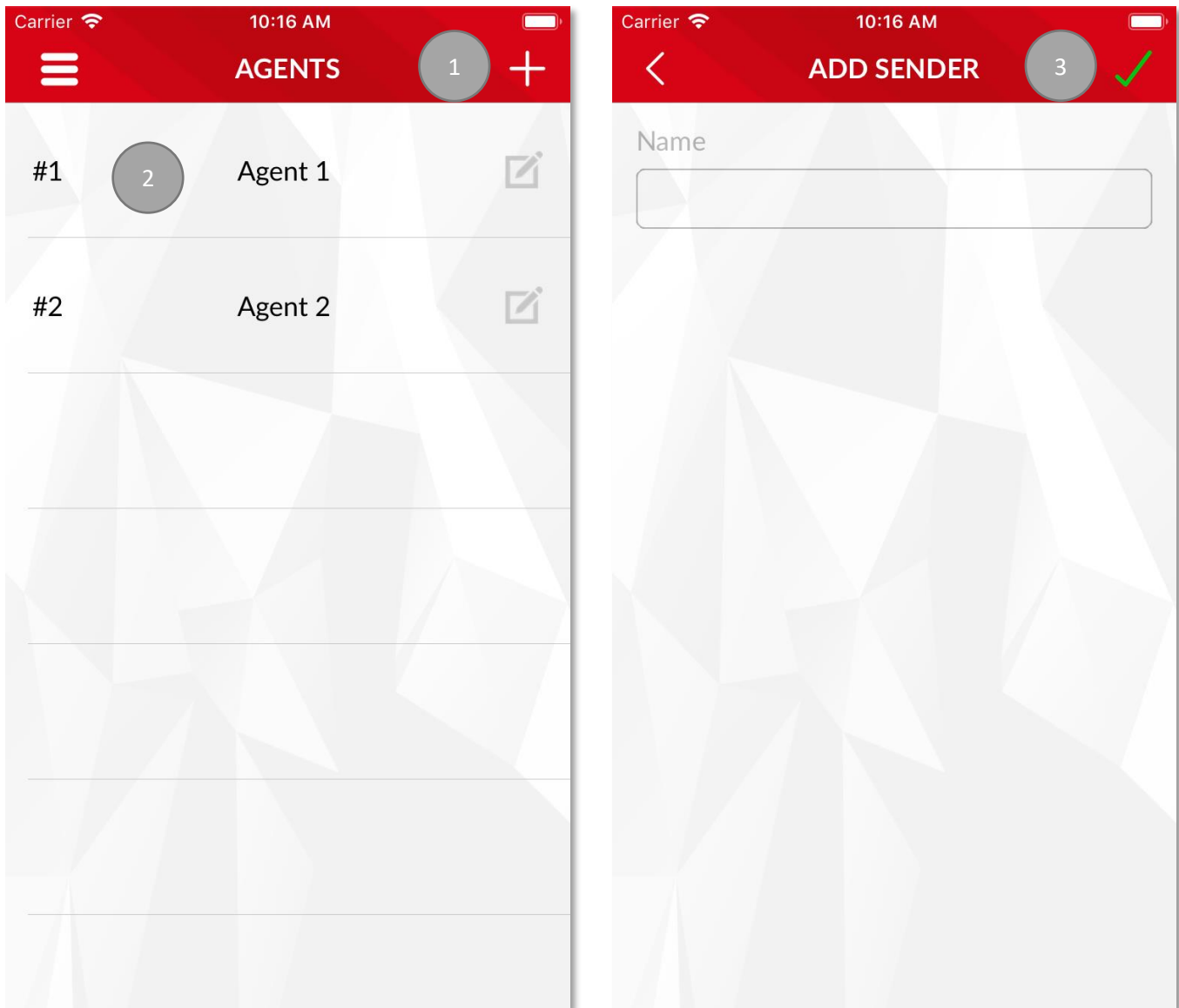

1. For create a new agent within your scale.
2. Press on agent item to edit it within your scale.
3. For save changes agent's data.

27.4.- OFFER SECTION.

On this section you can view offer's list, add and edit offers within your scale directly from Scale Link App.

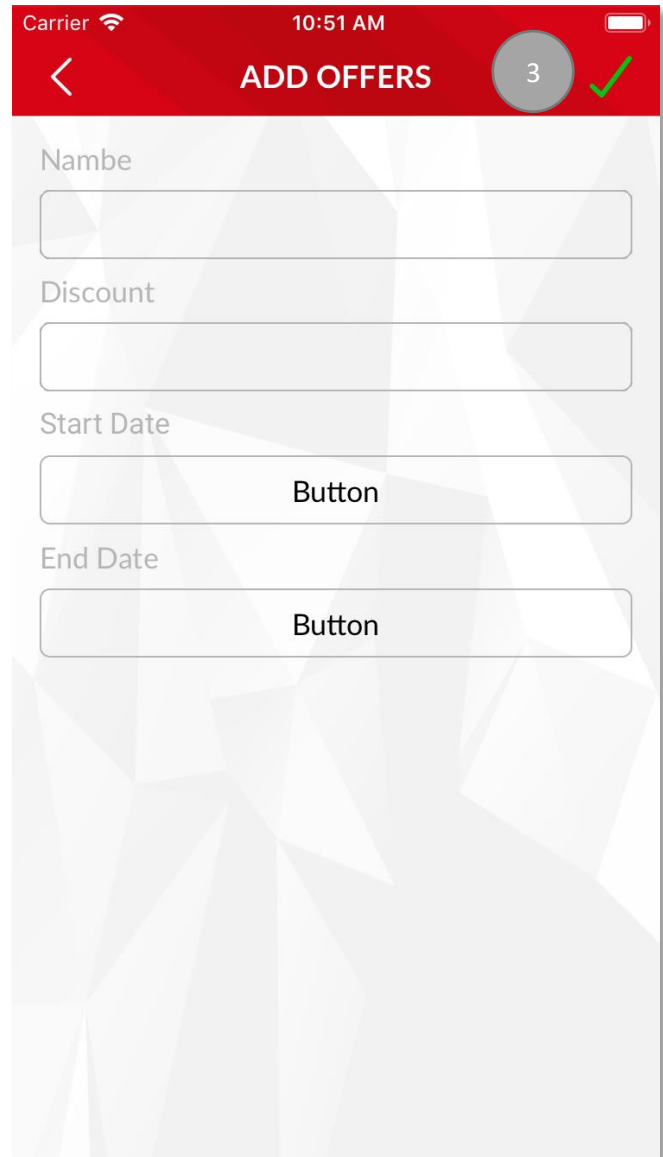
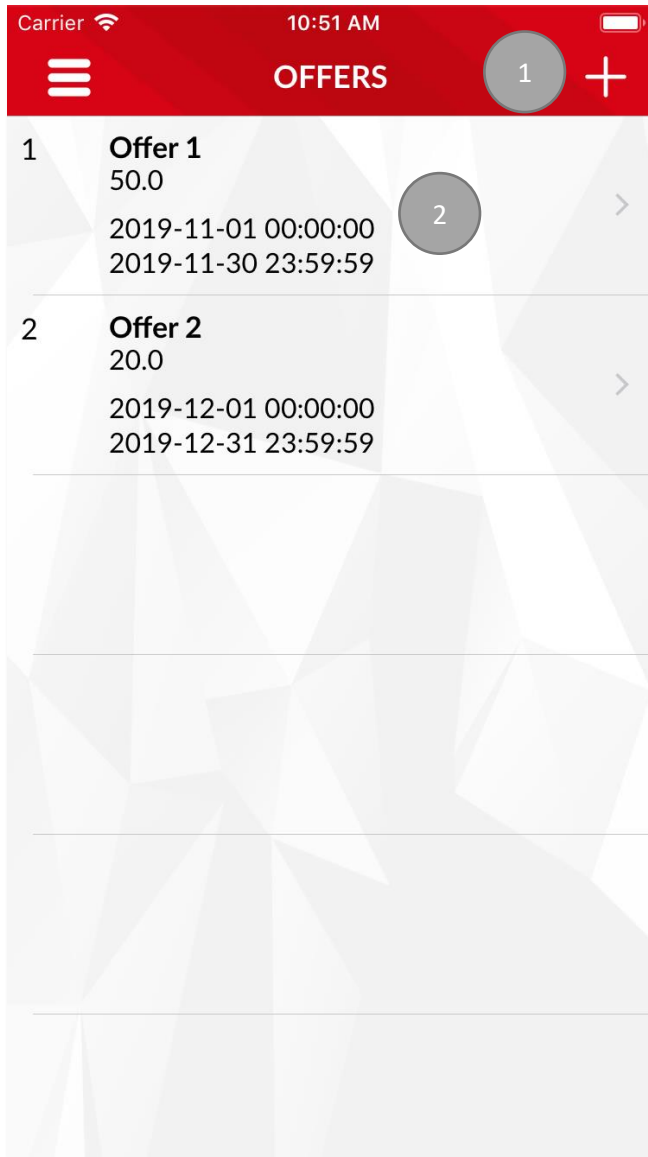

1. For create a new offer within your scale.
2. Press on offer item to edit it within your scale.
3. For save changes offer's data.

27.5.- ADDITIONAL INFORMATION SECTION.

On this section you can view offer's list, add and edit offers within your scale directly from Scale Link App.

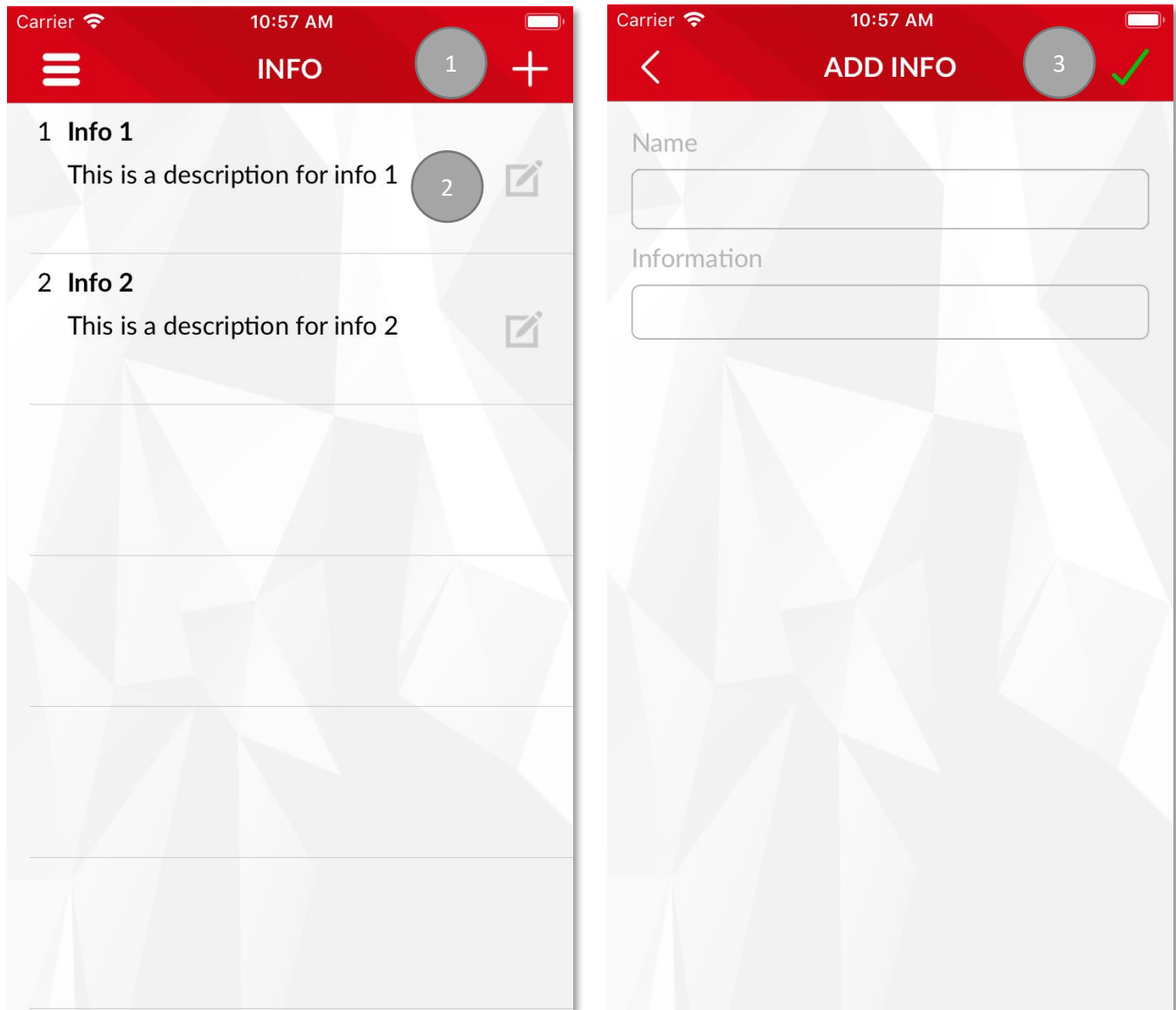

1. For create a new additional information within your scale.
2. Press on additional information item to edit it within your scale.
3. For save changes additional information's data.

27.6.- REPORT SECTION.

On this section you can view and export a history of your sale's report directly from Scale Link App.

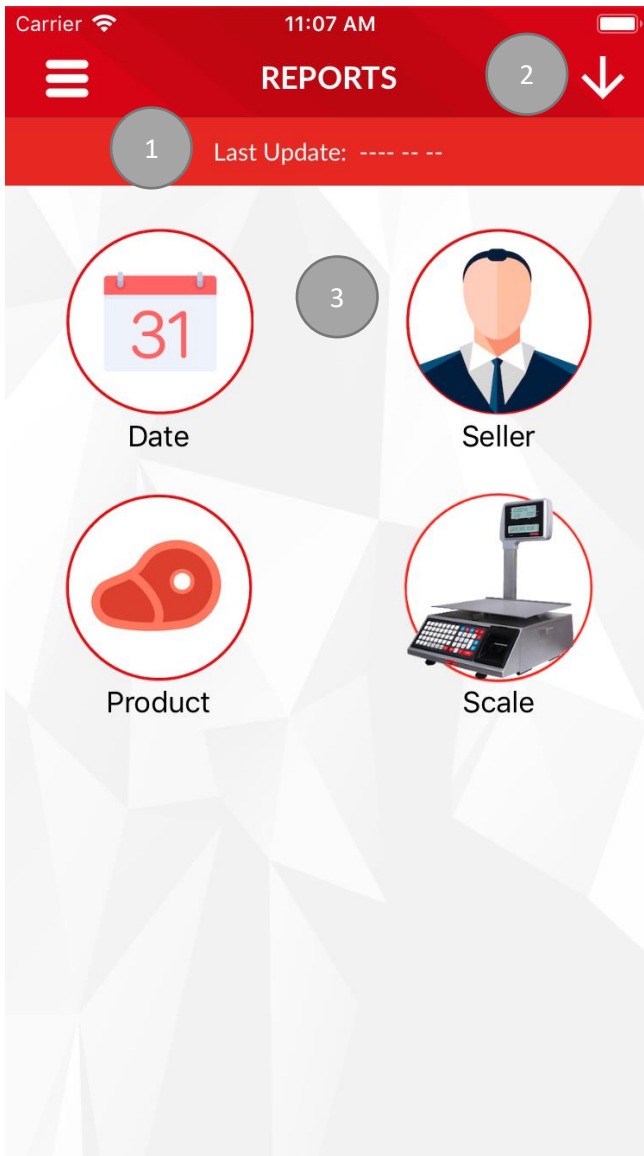

1. First time you access this section you see Last Update empty.
2. Button to download real-time sale's report from scale.
3. You can access every report by pressing on icons.
4. Total of current sale's report.
5. Button to export sale's report.

27.7.- SETTINGS SECTION.

When you access this section from Scale Link's menu, it will show you a submenu with available modules to manage directly from app, the next screenshot shows which modules you can manage to apply in scale.

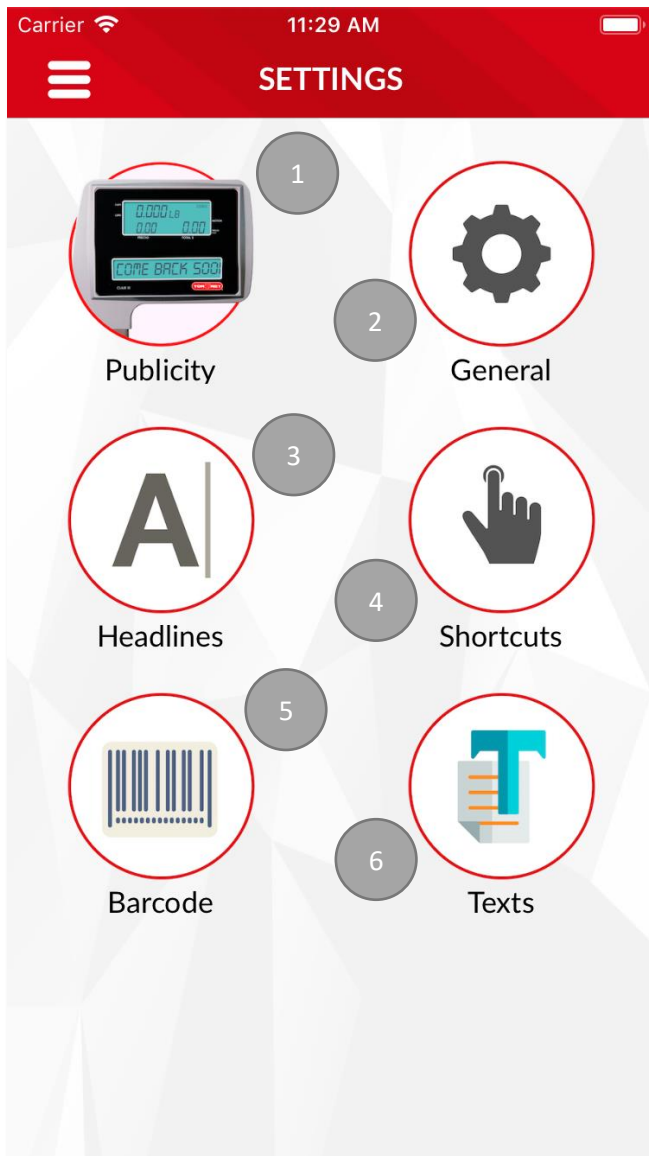

1. **Publicity**
Section to configure publicity messages for your customers.
2. **General**
Section to change general options, security passwords and date and time formats.
3. **Headlines**
Section to change ticket's header.
4. **Shortcuts**
Section to configure shortcuts for your scale.
5. **Barcode**
Section to configure barcode based on scale's paper.
6. **Text**
Section to change ticket's label.

27.7.1.- PUBLICITY.

This section allows to modify the default publicity messages for scale's rear display. Your customers are going to see these message in scale's torret.

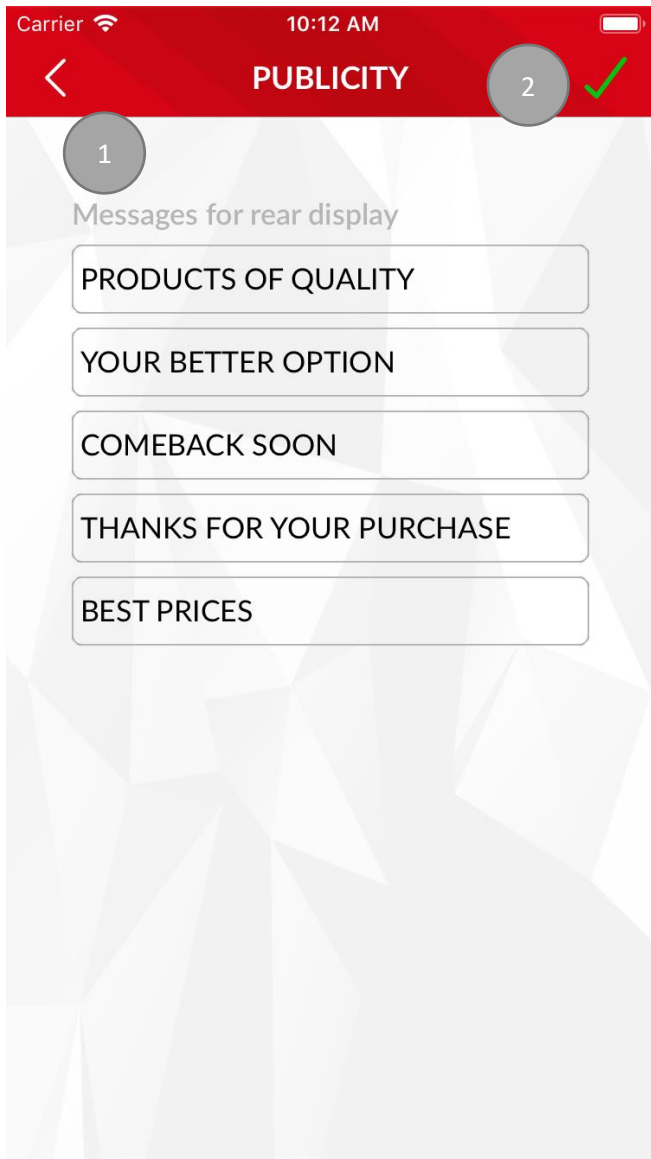

1. First time you access this section, you will see defaults messages for rear display.
You can change this message accord to your needs.
2. To save changes, press button with check image and you can see changes in real-time on the scale.

27.7.2.- SETTINGS.

This section allows you to enable and disable scale's functions such as general options, security password and date time formats.

Carrier 12:37 PM

GENERAL OPTIONS

1

Allow non PLU's	<input type="checkbox"/>	Allow Discounts	<input type="checkbox"/>
Allow PLU Return	<input type="checkbox"/>	Lock Price	<input checked="" type="checkbox"/>
Autoprint	<input type="checkbox"/>	Reprint	<input type="checkbox"/>

Security Passwords

2

Admin

123456

Supervisor

1234

Date and Time formats

3

Date

YYYY-MM-DD DD-MM-YYYY

Time

24 Hours AM/PM

1. Panel for enable or disable scale's functions.
2. Panel for change Admin and Supervisor password.
3. Panel for set date and time formats.

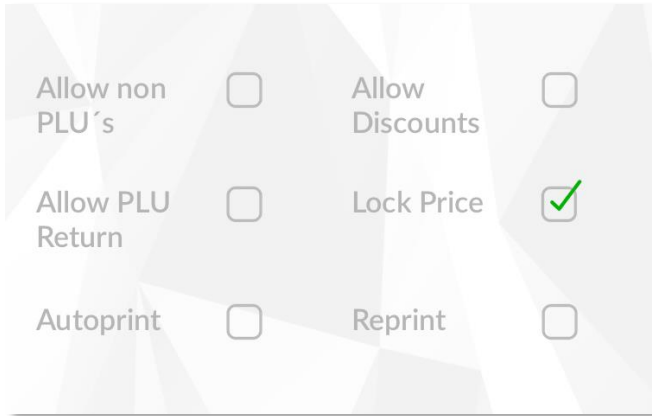

You can enable or disable scale's functions, options you will find to enable or disable are:

Allow non-PLU: It allows you to sell non-PLU products with the scale.

Allow Discounts: Allows you to apply up to 99% discounts to products using a supervisor password on the scale.

Allow Returns: It allows you to make returns of products by typing the supervisor password on the scale.

Block Price: Once this option is activated the user can't change a product's price.

Auto-Printing: Allows the labels to be printed without having to press the PRINT button.

RE-Printing: When this option is enabled the scale prints 2 tickets. (Only applies to tickets and no labels).

Security Passwords

Admin

Supervisor

Users can change the administrator and supervisor passwords of the scale.

Date and Time formats

Date

YYYY-MM-DD DD-MM-YYYY

Time

24 Hours AM/PM

The different types of date formats are:

dd/MM/yyyy This can be understood as Day/month/year.

MM/dd/yyyy This can be understood as month/day/year.

To have a 24 hours format select 24 Hours.

To have a 12 hours format select AM/PM.

27.7.3.- HEADLINES.

On this section you can change and configure until 15 headers for customer's ticket.

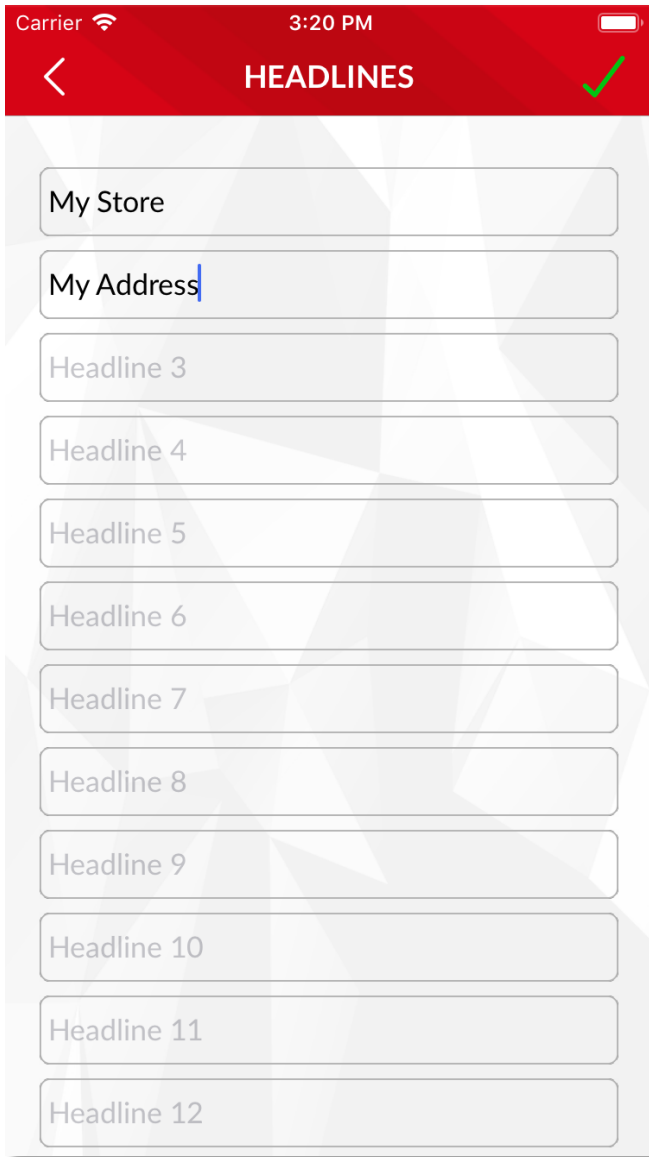

Once you configure the customer's ticket, you can press check mark image button for save the changes.

27.7.4.- SHORTCUTS.

On this section you can configure scale's shortcuts, W-Label can save until 35 shortcuts for your products.

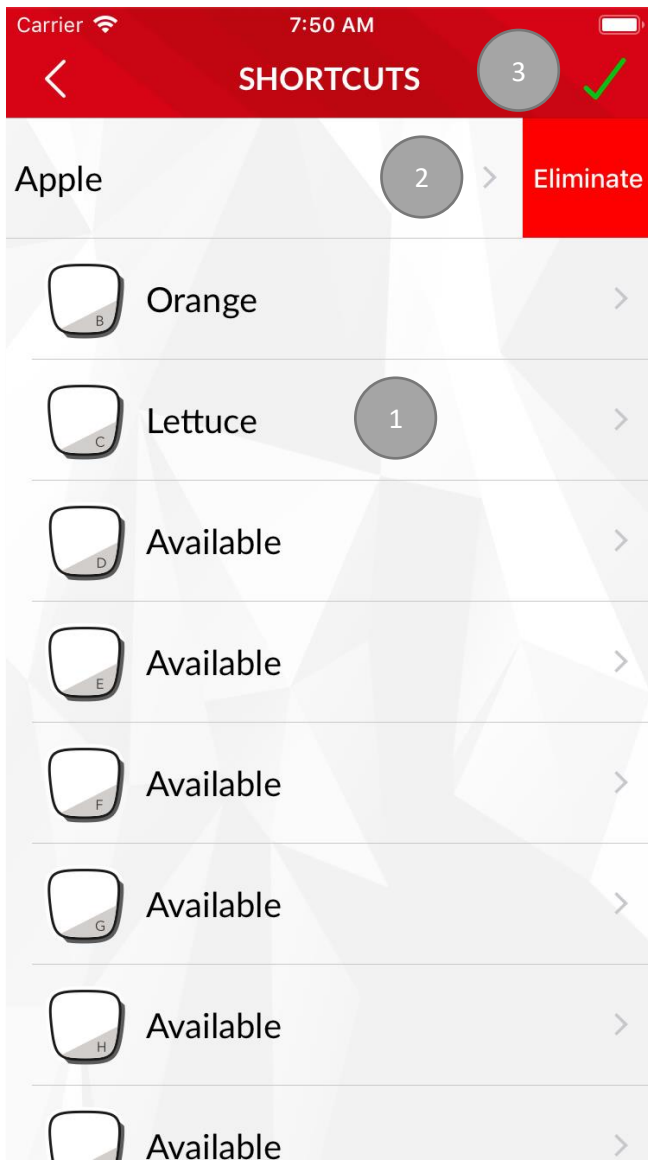

1. You can select any product of your scale and set the shortcut.
2. If you want to delete or replace one shortcut, you need to make a swipe left with your finger to make visible the Eliminate button.
3. To save the changes, press check mark image button.

27.7.5.- BARCODE.

This Screen allows you to choose from 2 predefined formats based on the type of paper on the scale.

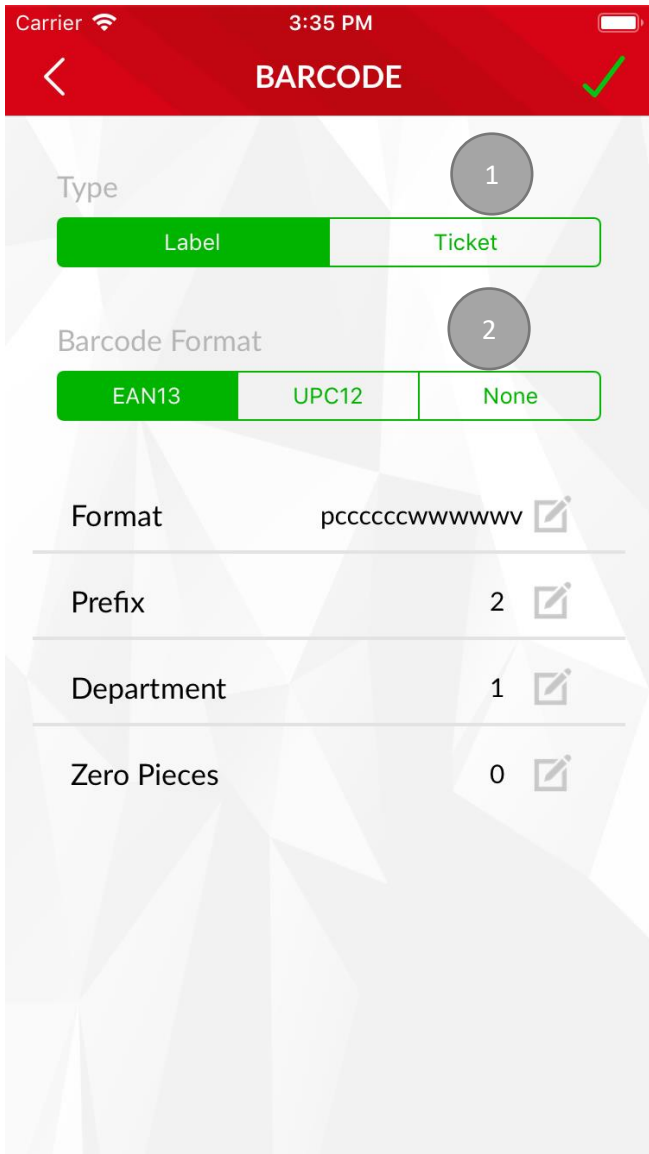

1. Printing format panel.
2. Barcode configurations panel.

Choose the barcode format you feel more comfortable with, barcode gets composed by the following parameters:

Letter	Meaning	Recommendation
A	AGENT	2
F	CONSECUTIVE	6
C	Product's code	6
W	Product's weight	5
T	Total	6
D	Department	2
N	Product's number	2
P	Prefix	2
X	Not read digit	-
V	Checker (non-editable -automatic)	-

Code Format – Weight:

EAN13: P C C C C C C W W W W W V

UPC12: X C C C C C C W W W W W V

Code Format – Total:

EAN13: P C C C C C C T T T T T V

UPC12: X C C C C C C T T T T T V

To customize the barcode format, choose CUSTOM introduce the content according to the list below.

- **Prefix:** Allows you to see and modify the prefix that gets printed at the beginning of the ticket.
- **Department:** Allows you to see and modify the department number assigned to the scale.

27.7.6.- TEXT.

This section allows you to modify the messages appearing on sale tickets or labels.

Carrier 10:16 AM

< TEXTS ✓

Weight Text
Weight kg

Price Text
Price \$/kg

Total Text
Total \$

Agent Text
Agent

Publicity Text
Thanks for your purchase

Footer Text
Items

Return Text
Return

Discount Text
Discount \$

Cash Text
Cash \$

1. **Weight's Text:** This text gets printed on top of the weight indicator. It's Weight lb. by default.
2. **Price Text:** this text gets printed on top of the Price indicator. By default, is "Price \$/lb."
3. **Total Text:** this text gets printed on top of the total amount on the ticket. By default, is "Total \$".
4. **Agent text:** Is the text that gets printed on top of the Agent's name.
5. **Publicity Text:** this is the text that gets printed on the publicity display, by default is: "Thank you for your purchase"
6. **Footer Text:** this text gets printed on the top of the items list. By default, is "Items".
7. **Return Text:** Applies on returns and by default is "Return".
8. **Discounts Text:** this text gets printed on the left side of discounts on the ticket.
9. **Piece Text:** this text gets printed on top of the quantity of a product.
10. **Ticket Price Text:** This text gets printed on top of the prices list column.

Changes Text

Change \$

Date Text

Packed

Due Date Text

Sale by

Tare Text

Tare

Weight Pieces Text

Count

Price Pieces Text

Price \$/Pcs

Ticket Weight Text

Weight Net/Cnt

Ticket Price Text

\$/kg \$/pcs

11. **Cash Text:** this text gets printed on top of the amount received by the customer.

12. **Change Text:** This text gets printed on the left side of the amount to give back to the customer.

13. **Date's Text:** This text gets printed on top of the date on the ticket.

14. **Expiration Date Text:** This text gets printed on top of the expiration date indicator on the ticket.

15. **Piece Price Text:** This text gets printed on top of the total amount.

16. **Tare Text:** This text indicates if the TARE function was activated during the sale.

17. **Ticket weight text:** This is the text that gets printed on top of the Price/Weight Indicator.

18. **Ticket Price Text:** This text gets printed on top of the Price of the product.