



OWNER'S MANUAL

PORTIONING SCALE



L-EQ HS Series

BEFORE OPERATING THIS SCALE, PLEASE READ THIS MANUAL THOROUGHLY.

INDEX

Important warnings	3
Introduction	5
Installation guide	5
Name and location of parts	6
Keyboard	7
LCD display screen	8
How to operate	9
How to weigh a product	9
How to use "TARE" function.	9
How to use "kg" / "lb" / "oz" keys.	9
How to use the "PRINT" key.	9
How to use "REFERENCE ZERO".	10
How to use the backlight.	10
How to use the alarm function.	10
PC communication	11
How to display weight measure on PC screen	11
Format of the data sent to the PC	11
Using Scale software	12
Power timer function.	13
Low battery indicator	13
Use of the battery	13
Other important messages that appear on the scale	14
Maintenance and cleaning	15
Troubleshooting guide	16
Technical specifications	17
Additional data	18

IMPORTANT WARNINGS

1. In case you have any problem with the scale, read the warranty conditions.



2. Do not open the scale your warranty will be canceled.



3. Do not press the keyboard with any sharp and/or pointed objects.



4. Use a VAC outlet exclusive for the scale, avoiding overloads or voltage variations.



5. Do not wash the scale using flow of water. This can damage the electronic components. For more information read "Maintenance and cleaning" section.



6. Protect the scale from insects; they can damage the electronic components. Use online solid products against insects.



7. Do not drop or hit the scale with the product to be weighted, this will damage the weight sensor.



IMPORTANT WARNINGS

8. Do not use solvents or detergents for cleaning, use only a damp towel.

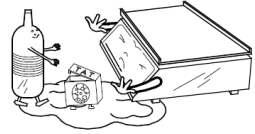

9. Do not place any fans or heaters directly into the scale.

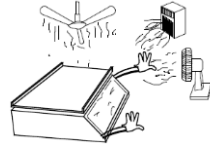

10. Do not place the scale where there is excess moisture or dust.



11. Only authorized and qualified personnel should inspect and repair the scale.



IMPORTANT

Battery should be recharged for 10Hrs before using the scale for the first time.



WARNING

Do not open the scale

Caution: to reduce the risk of short circuit in your scale, do not remove the cover or substitute any of the parts for others that are not original only authorized distributor.

INTRODUCTION

Dear customer:

We appreciate that you have chosen this product. We assure you that you will get the maximum satisfaction of the new acquisition for your business. We suggest you to read carefully this manual and make sure to keep it at hand for later consultations.

INSTALLATION GUIDE

1. Unpack the scale and check that it is in good condition. If you find any damage, notify your authorized dealer immediately.
2. Place the scale in a place free of movements and vibrations, make sure it is level, checking that the four leveling feet hold the scale on the surface where you have placed it and that the leveling bubble (under the plate) is centered. Adjust, tight or loose the leveling feet until the bubble is in the center of the circle.
3. Connect the AC/DC adapter (if used) to a 110/220VAC output.
4. Turn on the scale and observe in the viewer / screen:



IMPORTANT NOTE: If, when performing the steps described above, the scale shows the word "HELP" it means that it was mistreated and / or hit during transport, which caused irreversible damage. If so, contact your authorized dealer. It is also possible that the scale shows "HELP" when it is lit with a product on the plate, in this case, remove the weight from the scale, turn it off and then on again.

NAME AND LOCATION OF PARTS

1. **CABINET:** Stainless steel resistant to corrosion.
2. **PLATE:** Food grade, stainless steel with bent and rounded borders.
3. **PLATE HOLDER:** Made with high strength plastic.
4. **KEYBOARD:** Fast response, legible and easy to handle keyboard.
5. **DISPLAY:** Liquid crystal.
6. **ADJUSTABLE LEVELING FEET:** Loose or tight up them to adjust the scale.
7. **JACK:** DC power supply connection, located in the scale's base.
8. **LEVEL INDICATOR:** Used as a scale's leveling reference.
9. **POWER SUPPLY:** 110VAC/6VDC or 220VAC/6VDC (included).
10. **RS232 CONNECTOR:** To connect the scale with a PC or printer using a RS232 cable.
11. **TARE FOOTSWITCH CONNECTION:** To connect the external tare footswitch.

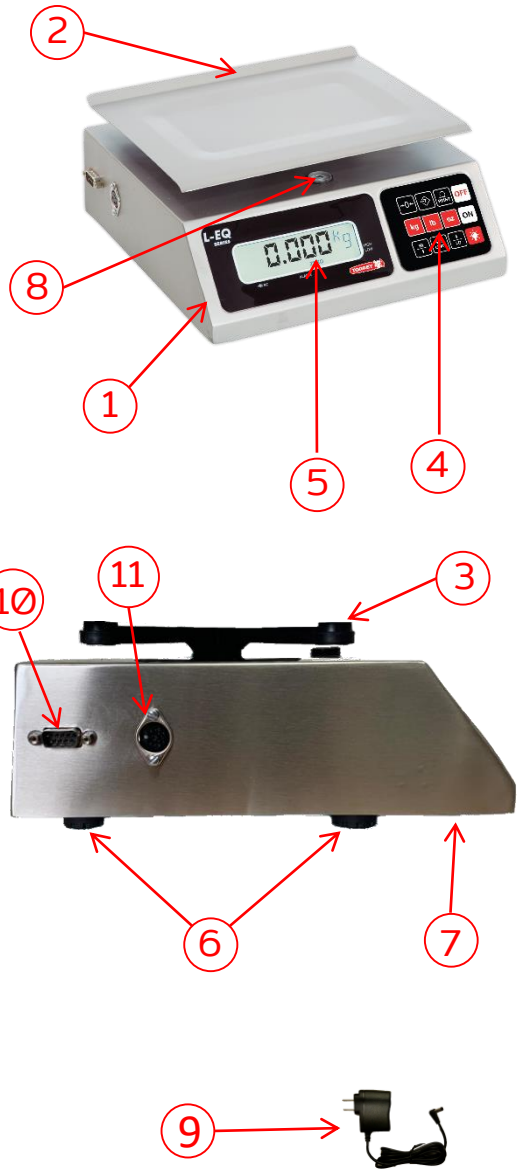

KEYBOARD

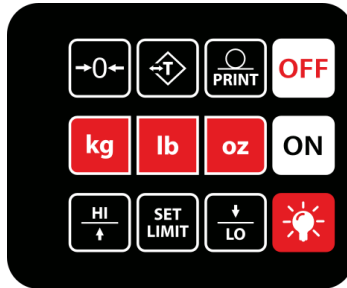

Turn on the scale.



Turn off the scale.



Show the weight on the PC screen. Communication through RS232.



Activate the TARA function.



Activate the ZERO function.



Show the weight in kg.



Show the weight in lb.



Show the weight in oz.



Increase the weight to be set for the weight alarm.



Decrease the weight to be set for the weight alarm.



Activates and sets the weight alarm.

LCD DISPLAY SCREEN

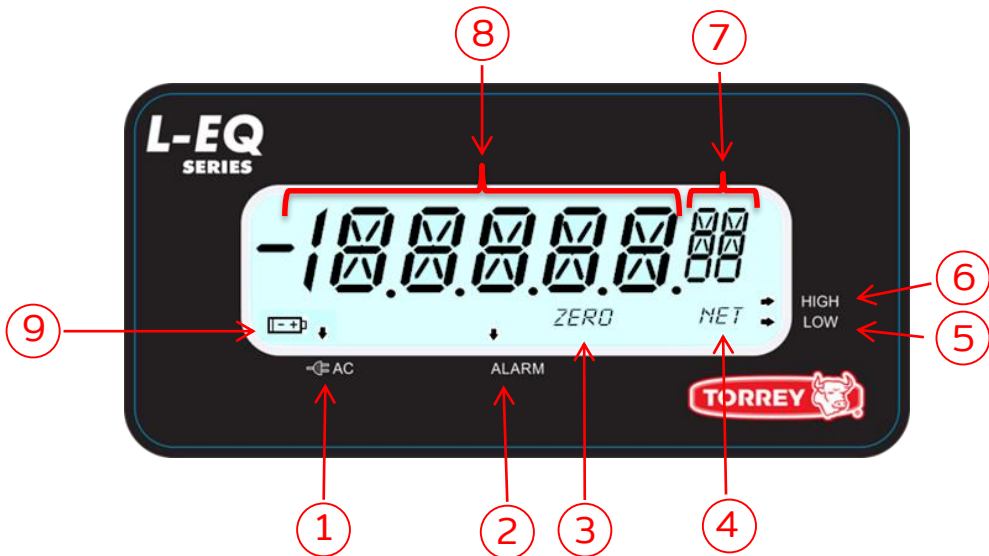

1. CONNECTED ELIMINATOR INDICATOR: appears when the battery eliminator is connected to the scale and in turn this is connected to a 110/220VAC outlet.
2. ACTIVE "ALARM" INDICATOR: means that a weight range has been set for the alarm.
3. "ZERO" INDICATOR: Shown when the weight on the plate is zero.
4. "NET" INDICATOR: indicates that the "tare" function has been activated. the readings shown correspond to the net weight.
5. "LOW" INDICATOR: Indicates that the weight on the plate is less than the lower limit of the interval set for the alarm.
6. "HIGH" INDICATOR: Indicates that the weight on the plate is greater than the upper limit of the interval set for the alarm.
7. WEIGHT UNIT INDICATOR: Displays the selected weight unit.
8. ALPHANUMERIC INDICATOR: Displays the weight and messages of the scale.
9. LOW BATTERY INDICATOR: appears when the battery power is low and indicates that it is necessary to recharge it.

HOW TO OPERATE

How to weight a product

Turn on the scale, place the product in the plate and the weight will be shown in the display; the symbols “kg”, “lb” or “oz” will appear depending on the unit previously selected.

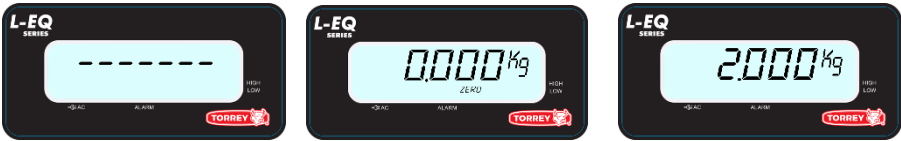

How to use “TARE” function

When you want to eliminate the weight over the container, press the “TARE” key and the display will start in zero. Now just weight the product. To end this function, remove the weight from the container and press the “TARE” key again.



How to use “kg” / “lb” / “oz” keys

The unit’s keys allow you to weight a product in kilograms, pounds or ounces. If you weight a product in pounds and want to convert that weight into kilograms, just press the “kg” key and the scale will convert it automatically.

How to use the “PRINT” key

When you press the “PRINT” key, the scale will send the data shown in the display to a PC. To activate this function, the scale should be connected to the computer.

How to use "REFERENCE ZERO"

If the scales shows weight in the display without having any product over it, may be caused by voltage variations, rough use, etc. In this case, press the "ZERO" key and the display will return back to zeros.

How to use the backlight

In case of having not enough light for a optimum visibility, use the scale's backlight to improve the legibility of the display's data. To turn on the backlight press this key:



How to use the alarm function

To activate the alarm function, press the "SET LIMIT" key, "HI LMT?" will be shown; press the "HI" key to increase or the "LO" key to decrease the highest limit value. Press again the "SET LIMIT" key, "LO LMT?" will be shown and repeat the same procedure, press once again the "SET LIMIT" key to save the alarms limits and start weighting.



PC COMMUNICATION

How to display weight measure on PC screen

To be able to transmit the scale's data to your computer, please follow these steps:



•Connect your scale to the computer using a RS232 cable.



•Send "P" letter (or equivalent on ASCII code) from the computer.



•Scale will send a weight measure + "CC" (control character).

Format of the data sent to the PC

Usually, through the computer, the data following are sent in ASCII and hexadecimal code (Control character "CC" is equal to "OD" in all examples)

N	E	T																	
N	E	G	.																
R	A	N	G	E															
O	V	E	R		L	O	A	D											
O	U	T		O	F		R	A	N	G	E								

Text section.

C	R		-	#	#	#	.	#	#	#									
---	---	--	---	---	---	---	---	---	---	---	--	--	--	--	--	--	--	--	--

Weight section.

	k	g																	
	l	b																	
	o	z																	

C	R
---	---

Unit section.

USING SCALE SOFTWARE

You can use the scale program to display the weight sent by the scales to your PC.

For installation first download the "Software Scale for Windows" on our page <http://www.torrey-cloud.com/downloads/>, In section "PPT Torrey Software".

Steps to establish communication with the PC using the "Scale" software:

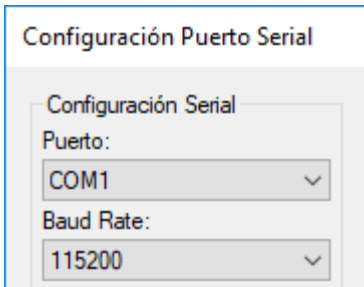

Select "Configuración Puerto Serial", choose a Baud Rate (9600 bps recommended) and the Port which your computer recognized the scale.

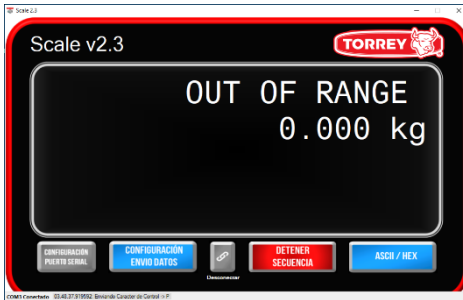

Select Conectar and next Empezar Secuencia, immediately you would see the weight on your PC screen in real time. To stop the communication select Desconectar.

POWER TIMER FUNCTION

This function is activated when the scale is turned on without the AC/DC power supply. When the scale is not used during approximately 15 minutes it will automatically be turned off.

LOW BATTERY INDICATOR

If the battery does not have enough charge the low battery's indicator will appear in the display, it is possible to keep on working with the scale for 30 minutes. If the message "LOW BAT" appears in the display, the scale will stop working; connect it to the AC/DC power supply to recharge.

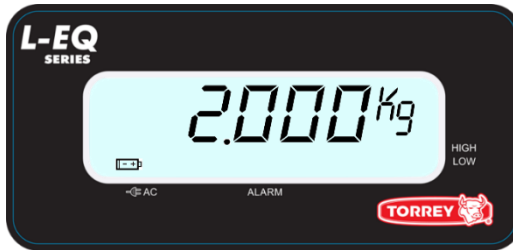

USE OF THE BATTERY

The scale can operate using the rechargeable battery (4 VDC- Included) or with the AC/DC power supply. The battery is recharged by being connected with the AC/DC power supply during approximately 10 hours with the scale turns off. Once charged, it may last up to 100 hours of continuous use.

NOTE: Battery must be recharged before operating the scale for 10 hours.

OTHER IMPORTANT MESSAGES THAT APPEAR ON THE SCALE

OVER LOAD

This message indicates that a weight that exceeds the maximum capacity has been placed on the scale. To correct it, simply remove the overweight.



HELP

This message appears in two different situations:

1. When the scale is turned on with an excess weight on the plate near half the scale's capacity. To correct this situation remove the weight on the scale, turn the scale off, and then back on again.
2. When the scale has been handled roughly and/or hit.

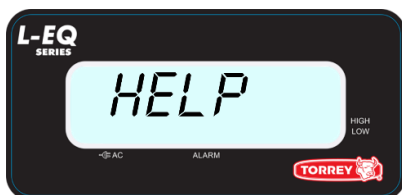

NEG.

This message indicates a negative weight, to fix this place back in its plate and press the $\rightarrow \emptyset \leftarrow$ key, or turn the scale off and then turn it back on again.

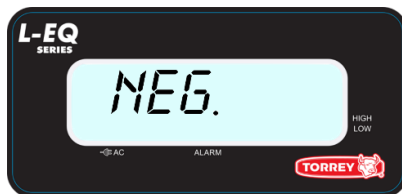

LOW BAT

This message appears when the battery charge is not enough to keep the scale on and therefore turns off.



MAINTENANCE AND CLEANING

One of the greatest advantages of purchasing this scale model is that it requires minimum maintenance and it is very simple to keep it in favorable conditions.

- Do not use a flow of water to clean your scale. Use a damp rag and clean each of these components daily: plate and keyboard.
- To remove oil and greasy substances, use a dry and clean rag, rubbing dirty area several times.
- Do not use detergents or corrosive liquid while cleaning.
- Do not place the scale where there is a lot of moisture and/or dust.
- When you clean the scale make sure that there are not any papers, pieces of meat or any other kind of material under the plate or under the plate-holder that could obstruct the adequate operation of your scale.
- Periodically check the jack (where the AC/DC power supply is inserted) to make sure it is in good condition. That is, check there are not signs of strokes or detachments.
- Periodically check the AC/DC power supply to make sure the ends are in good condition, and that the cable is not twisted or tangled.
- Regularly check the scale to assure it is correctly leveled with its four leveling bases well supported.
- Do not expose your scale to temperatures below 14°F (-10°C) or for above 104°F (40°C).
- Never press the keyboard with objects such as pencils, pens, knives, etc.
- Do not drop or hard weight the product on the plate or the scale because with the time it could damage the load cell.

TROUBLESHOOTING GUIDE

Before you call for service to your authorized distributor, check this manual again to avoid a misunderstanding.

PROBLEM	POSSIBLE CAUSE	SOLUTION
The scale does not turn on	There is not electric current.	With a multimeter check the current outlets.
	AC/DC power supply cable has an unconnected wire or defectuous voltage outlet.	Check the AC/DC power supply terminals, if it is possible, check with another AC/DC power supply.
	Low battery.	Connect the AC/DC power supply and verify that the battery is been recharged. If not replace the battery
The scale shows different weights with the same product	Material under the plate.	Check if exists materials under the platform. If so, remove them and check the operation again.
The word "HELP" appears in the display	The scale was turned on with a weight over the plate.	Remove the weight, turn off the scale and then turn it on again.

TECHNICAL SPECIFICATIONS

L-EQ 5/10-HS	L-EQ 10/20-HS
MAX. 5kg / 10lb / 160oz	MAX. 10kg / 20lb / 320oz
MIN. 20g	MIN. 40g
MIN. DIV. 0.001kg / 0.002lb / 0.05oz	MIN. DIV. 0.002kg / 0.005lb / 0.1oz
MAX. TARE 5kg / 10lb / 160oz	MAX. TARE 10kg / 20lb / 320oz
OPER. TEMP. -14°F to 104 °F	OPER. TEMP. -14°F to 104 °F

MAX. = MAXIMUM CAPACITY.

MIN. = MINIMUM CAPACITY.

MAX. TARE = MAXIMUM TARE.

OPER. TEMP.= OPERATING TEMPERATURE.

POWER SUPPLY INPUT: 110/220VAC

POWER SUPPLY OUTPUT: 6VDC 500mA

BATTERY: 4VDC 2.5A/h

NOTE: BATTERIES CAN ONLY BE RECHARGED FROM 32°F TO 104°F

STORAGE TEMPERATURE -4°F TO 122°F.

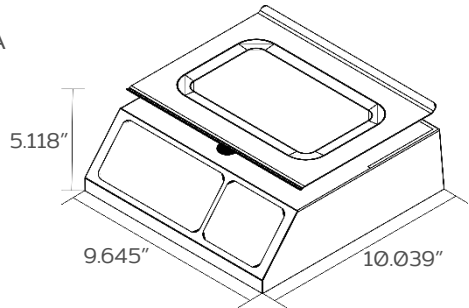

ADDITIONAL DATA

The serial number of this product can be found in the identification information which is located at the top of the scale's cabinet. We suggest you that write the serial number and the scale model in the following spaces and hold them as proof of your acquisition and as identification in case of loss or to future request.

Distributor _____

Address _____

Telephone number _____

Purchase date _____

Purchase date _____

Serial number _____

We reserve the right to change any specification contained in this text without prior notice.



ELECTRONIC
SCALE

www.torrey.net